

74-3800 Series

Regulators - Pressure Reducing

D74381734X012

Specifications

For other materials or modifications, please consult TESCOM.

OPERATING PARAMETERS

Pressure rating per criteria of ANSI/ASME B31.3

Maximum Inlet Pressure

600, 1000, 3500 psig / 41.4, 69.0, 241 bar

Outlet Pressure Ranges

30, 60, 100, 150 psig / 2.1, 4.1, 6.9, 10.3 bar

Design Proof Pressure

150% of maximum rated

Inboard Leak Rate

$< 1 \times 10^{-9}$ atm cc/sec He, per ASTM E449

Operating Temperature

VespeI®: -40°F to 350°F / -40°C to 177°C

PCTFE: -40°F to 140°F / -40°C to 60°C

Teflon® PFA: -40°F to 160°F / -40°C to 71°C

Flow Capacity

$C_v = 0.5$

Decaying Inlet Characteristic

1.3 per 100 psig / 0.09 per 6.9 bar

MEDIA CONTACT MATERIALS

Body

316L VAR Stainless Steel with Electropolish

Diaphragm

316 Stainless Steel or Hastelloy®

Valve Seat

VespeI® (3500 psig / 241 bar Inlet)

PCTFE (600, 100 psig / 41.4, 6.9 bar Inlet)

Teflon® PFA (600 psig / 41.4 bar Inlet)

Remaining Parts

316 Stainless Steel

OTHER

Internal Surface Finish

10 R_a microinch / 0.25 micrometer

Connections

Welded female or male VCR®

Tube stubs

Compression

High Purity Internal Connections (H.P.I.C.)

(Internal style of VCR®, compatible with male swivel VCR®)

Internal Volume

15 cc

Weight (without gauges)

3.2 lbs / 1.5 kg

Teflon® and VespeI® are registered trademarks of E.I. du Pont de Nemours and Company.

VCR® is a registered trademark of Cajon Co.

Hastelloy® is a registered trademark of Haynes International, Inc.



TESCOM 74-3800 Series ultra high purity, tied diaphragm pressure reducing regulator offers high flow and internally threadless and low internal volume design with $C_v = 0.5$. The 74-3800 Series is available with 10 R_a surface finish. Inlet pressures are 600, 1000, or 3500 psig / 41.3, 69, 241 bar with outlet pressures up to 150 psig / 10.3 bar.

Applications

- 1/2" point-of-use pressure regulator
- Gas cabinets
- High flow purging systems
- Semiconductor manufacturing

Features and Benefits

- Internally springless and threadless design
- Metal-to-metal diaphragm to body seal for high leak integrity
- Smooth unobstructed flow path allows for complete purging
- Positive shut-off seal, tied diaphragm design with positionable captured vent bonnet
- Hastelloy® trim option is available

74-3800 Series Regulator Drawing

FIGURE A (NO GAUGE)

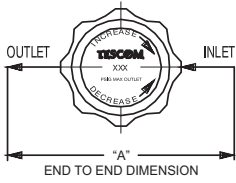

FIGURE B (2 GAUGES)

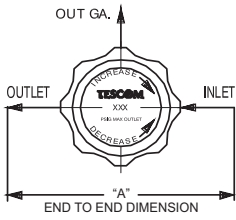
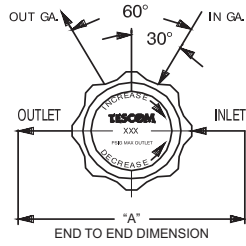

FIGURE C (1 GAUGE)

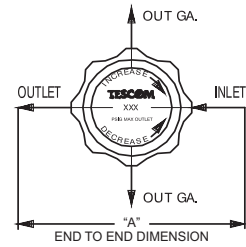
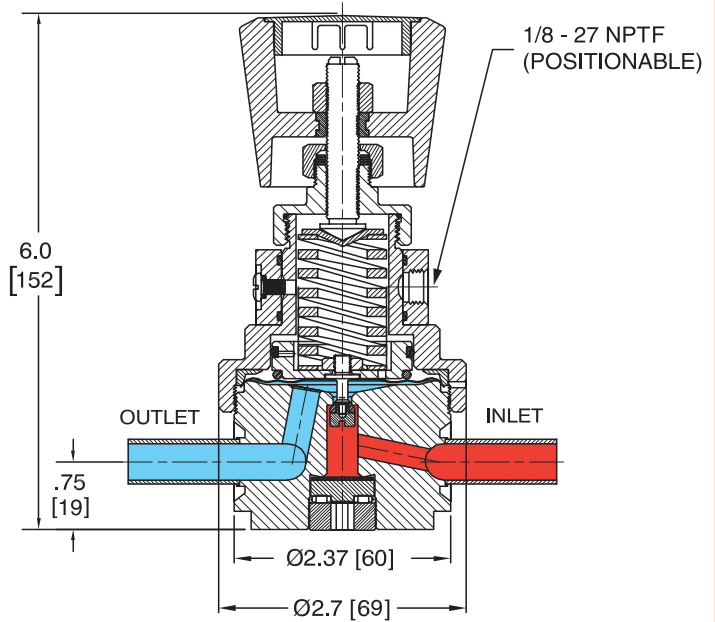
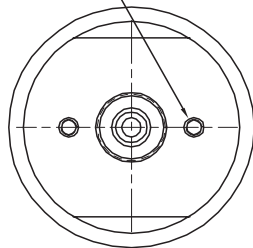

FIGURE D (2 OUTLET GAUGES)



M5 X .30 DEPTH (2X)
ACCEPTS #10-32
UNF SCREW



2X .20 DIA. [5]
TWO HOLES

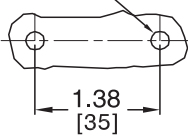

PANEL CUT OUT

All dimensions are reference & nominal
Metric [millimeter] equivalents are in brackets

74-3800 Series Regulator Flow Chart

For more information on how to read flow curves, please refer to the Flow Curves and Calculations document (debul2007x012) in the TESCOM catalog or on www.tescom.com.

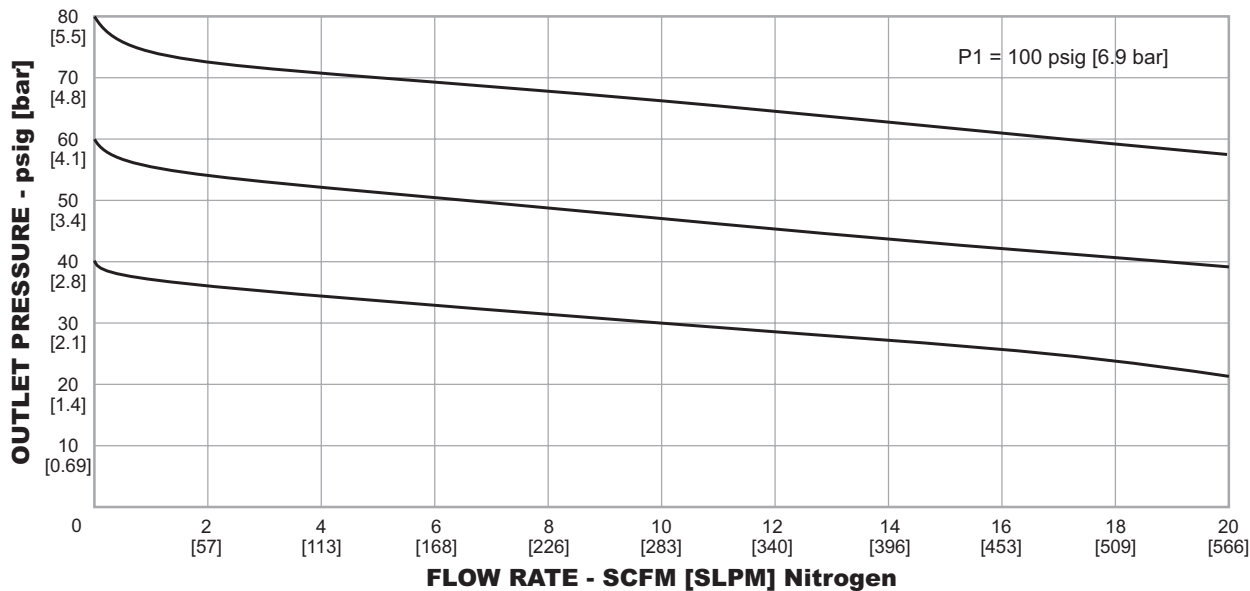

74-3800 Series Regulator Part Number Selector

Repair Kits, Accessories & Modifications may be available for this product. Please contact TESCOM for more information.

Example for selecting a part number:

74-38	6	2	K	RW	1	0			
BASIC SERIES	BODY MATERIAL	FINISH	OUTLET PRESSURE	SEAT MATERIAL	INLET AND OUTLET PORT SIZE AND TYPE	'A' ± .06"	INLET PRESSURE	GAUGE PORT OPTIONS	NUMBER OF GAUGE PORTS (FIGURE)
74-38	6 – 316L VAR Stainless Steel Electropolish	10 R _a ¹	0 – 30 psig 2.1 bar 1 – 60 psig 4.1 bar 2 – 100 psig 6.9 bar 3 – 150 psig 10.3 bar	V – Vespel® (3500 psig / 241 bar only) K – PCTFE (600 and 1000 psig / 41.4 and 69.0 bar only) T – Teflon® PFA (600 psig / 41.4 bar only)	C6 – 3/8" Compression C8 – 1/2" Compression RU – 1/2" Male Swivel RW – 1/2" Female Swivel T6 – 3/8" Tube Stubs T8 – 1/2" Tube Stubs	6.42 6.00 5.59 5.59 3.70 3.70	SST Trim 1 – 3500 psig 241 bar 2 – 1000 psig 69.0 bar 3 – 600 psig 41.4 bar Hastelloy® Trim 4 – 1000 psig 69.0 bar 5 – 3500 psig 241 bar 6 – 600 psig 41.4 bar	0 – None 1 – 1/4" H.P.I.C. 2 – 1/4" H.P.I.C. 3 – 1/4" H.P.I.C. 4 – 1/4" Male Swivel 5 – 1/4" Male Swivel 6 – 1/4" Male Swivel 7 – 1/4" Female Swivel 8 – 1/4" Female Swivel 9 – 1/4" Female Swivel	0 (Figure A) 1 (Figure C) 2 (Figure B) 2 (Figure D) 2 (Figure D) 1 (Figure C) 2 (Figure B) 2 (Figure D) 1 (Figure C) 2 (Figure B) 2 (Figure D)

1. Per SEMI F19, HP grade



WARNING! Do not attempt to select, install, use or maintain this product until you have read and fully understood the *TESCOM Safety, Installation and Operation Precautions*.

D74381734X012 © 2012 Emerson Process Management Regulator Technologies, Inc. All rights reserved. 05/2012.
Tescom, Emerson Process Management, and the Emerson Process Management design are marks of one of the Emerson Process Management group of companies. All other marks are the property of their respective owners.