

Section 2

Schedule 80 CPVC Piping System

Serviced by GF Little Rock

Effective March 27, 2006

Pipe, Valves and Fittings
Sizes 1/4" to 12"

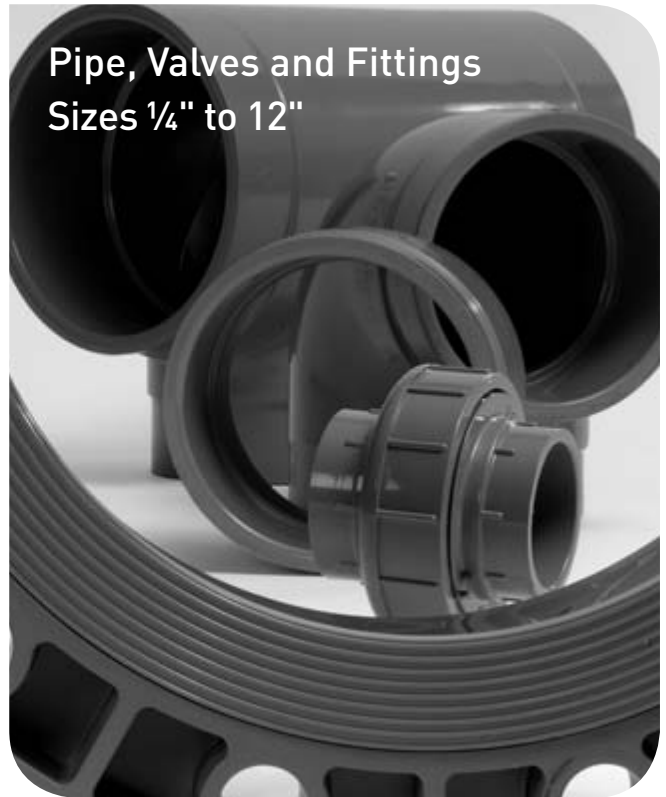

Glossary

- Std. Pack** = Standard Carton Quantity
- FPT** = Female Pipe Thread
- MPT** = Male Pipe Thread
- S** = Tapered Socket
- SPG** = Spigot End (same dimension as pipe outside diameter)
- *** = Non-Returnable / Non-cancellable
- ^** = 40% Restocking Fee
- HS** = High Strength Design
- SL** = Streamline Design
- XXXX-XXXFB** = Assembled Fitting from Molded Components
- XXXX-XXXH** = Fabricated Fitting

Product Line	Descriptions	Discount
70	CPVC Pressure Pipe-20ft. Lengths Plain End	_____
25	CPVC Pressure Fittings - Molded	_____
34	CPVC Pressure Expansion Joint	_____
33	CPVC Pressure Brass Insert Fittings	_____
02	CPVC Pressure LD Fittings - Molded	_____
06	CPVC Pressure LD Fittings - Fabricated	_____
38	CPVC Type 546 True Union Ball Valve	_____
15	CPVC Type 375 True Union Ball Valve	_____
74	CPVC Type 567 Butterfly Valve	_____

The technical information given in this publication implies no warranty of any kind and is subject to change without notice. Please consult our Terms and Conditions of Sale.

Not for Use with Compressed Air or Gases

DO NOT TEST with Air or Air over Water

GF Piping DOES NOT RECOMMEND the use of thermoplastic piping products for systems to transport or store compressed air or gases, or the testing of thermoplastic piping systems with compressed air or gases in above or below ground locations. The use of GF Piping products in compressed air or gas systems automatically voids the warranty for such products, and their use against our recommendation is entirely the responsibility and liability of the installer. GF Piping will not accept responsibility for damage or impairment from its products, or other consequential or incidental damages caused by misapplication, incorrect assembly, and/or exposure to harmful substances or conditions.

For more information about any of our product lines, please call (800) 423-2686.

Table of Contents

Schedule 80 CPVC Piping System

Specifications, Standards and Tolerances	2.4
--	-----

Pipe (1/2"-12")	2.5
-----------------	-----

Fittings (1/4"-8")

Molded	2.6
Expansion Joint	2.18
Brass Insert	2.19

Large Diameter Fittings (10"-12")

Pressure Large Diameter Molded	2.20
Pressure Large Diameter Fabricated	2.21

Manual Valves

Type 546 and Type 375 ball valves	2.25
Type 567 butterfly valve	2.26

Specification Submittal Data Sheet	2.28
------------------------------------	------

Specifications, Standards and Tolerances

Specifications and Standards

NSF/ANSI Standard 14

NSF/ANSI Standard 61

ASTM D 1784 : Material CPVC Type IV, Grade I Gray (cell classification 23447-B)

ASTM F 441 : CPVC Schedule 80 Pipe

ASTM F 439 : CPVC Schedule 80 Socket & Threaded Fittings

ASTM F 437 : CPVC Schedule 80 Threaded Fittings

ASTM F 1970 : CPVC Schedule 80 Unions & Flanges

ANSI B16.5 : Flange Bolt Hole Patterns

ANSI B1.20.1 : CPVC Schedule 80 NPT Threads

CSA B137.6 : CPVC Schedule 80 Pipe (1¼" - 2½" only)

Molded Dimension Tolerances

A Piston Position; Expansion Joints : ± 0.03

D Outside Diameter : ± 0.06

G, G1 Intersections of centerlines to bottom of socket; 90° Ells, Tees : up to 4" ± 0.03 ; 6" and above ± 0.06

GJ, GN Intersections of centerlines to bottom of socket; 45° Wyes : up to 4" ± 0.03 ; 6" and above ± 0.06

H, HJ, HN Intersections of centerlines to face of fitting; 90° Ells, 45° Ells, Tees, 45° Wyes : up to 4" ± 0.03 ; 6" and above ± 0.06

HL Socket Bottom to Face of Fitting : up to 4" ± 0.03 ; 6" and above ± 0.06

J Intersections of centerlines to bottom of socket; 45° & 30° Ells : up to 4" ± 0.03 ; 6" and above ± 0.06

L Overall Length of fitting : ± 0.06

N Socket Bottom to Socket Bottom; Couplings, Unions : ± 0.06

N1 Socket Bottom to Face of Flange : ± 0.06

R Thickness on Plugs, Flanges : ± 0.03

T, T1 Effective Thread Length : Reference Only

W Height of Cap : ± 0.06

Fabricated Dimension Tolerances

D Outside Diameter : ± 0.50

E Drive Pin Diameter : ± 0.50

G, G1 Intersections of centerlines to bottom of socket; 90° Ells, Tees, Crosses : ± 0.25

GJ, GN Intersections of centerlines to bottom of socket; 45° Wyes : ± 0.25

H, HJ, HN Intersections of centerlines to face of fitting; 90° Ells, 45° Ells, Tees, 45° Wyes, True Wyes : ± 0.50

HL Socket Bottom to Face of Fitting : ± 0.25

J Intersections of centerlines to bottom of socket; 11¼°, 15°, 30°, 22½°, 45° Ells, True Wyes : ± 0.25

L Overall Length of fitting : ± 0.50

N Socket Bottom to Socket Bottom; Couplings : ± 0.50

N1 Socket Bottom to Face of Flange : ± 0.50

R Thickness on Plugs, Flanges : ± 0.25

T, T1 Effective Thread Length : Reference Only

W Height of Cap : ± 0.25

Schedule 80 CPVC Pressure Pipe

P/L 70 : CPVC Pressure Pipe - 20 ft. lengths Plain End

Size	Part Number Plain End	List \$/100 ft.	Lift Qty (ft.)	Average O.D.	Min. Wall	psi at 73° F
1/2	*C8008-005AB	See Note	5600 ft.	0.840	0.147	848
3/4	*C8008-007AB	"	5000 ft.	1.050	0.154	688
1	*C8008-010AB	"	2360 ft	1.315	0.179	630
1 1/4	*C8008-012AB	"	1960 ft	1.660	0.191	520
1 1/2	*C8008-015AB	"	1800 ft	1.900	0.200	471
2	*C8008-020AB	"	1060 ft	2.375	0.218	404
2 1/2	*C8008-025AB	"	880 ft	2.875	0.276	425
3	*C8008-030AB	"	700 ft	3.500	0.300	375
4	*C8008-040AB	"	520 ft	4.500	0.337	324
6	*C8008-060AB	"	220 ft	6.625	0.432	279
8	*C8008-080AB	"	100 ft	8.625	0.500	246
10	*C8008-100AB	"	80 ft	10.750	0.593	230
12	*C8008-120AB	"	60 ft	12.750	0.687	230

Note: For current pricing information please see separate price sheet or visit our website at www.gfpiping.com

Schedule 80 CPVC

^ = 40% Restock Charge

* = Non-Cancelable / Non-Returnable

Dimensions are subject to change. Please see online "Price Lists" at <http://www.gfpiping.com> for up-to-date information.

Schedule 80 CPVC Pressure Fittings

P/L 25 : CPVC Pressure Fittings - Molded

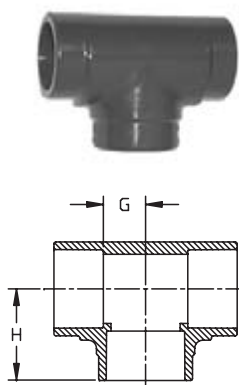

Tee (S x S x S)

Size	Part Number	\$ List/ea.	Std Pack	H	G	Design
1/2	9801-005	10.46	25	1.49	0.50	SL
3/4	9801-007	10.66	15	1.61	0.56	SL
1	9801-010	13.06	20	1.86	0.72	SL
1 1/4	9801-012	27.53	5	2.19	0.91	SL
1 1/2	9801-015	31.57	5	2.44	1.06	SL
2	9801-020	35.13	5	2.78	1.29	SL
2 1/2	9801-025	89.42	5	3.33	1.50	HS
3	9801-030	89.42	5	3.75	1.85	HS
4	9801-040	119.02	5	4.63	2.38	HS
6	9801-060	309.68	2	6.63	3.55	HS
8	9801-080	887.10	1	8.63	4.59	HS

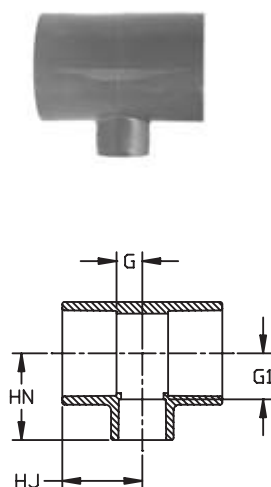

Reducing Tee (S x S x S)

Size	Part Number	\$ List/ea.	Std Pack	HJ	HN	G	G1	Design
3/4x1/2	9801-101	23.88	25	1.63	1.63	0.61	0.73	SL
1x1/2	9801-130	27.50	25	1.88	1.63	0.73	0.75	SL
1x3/4	9801-131	27.50	20	1.88	1.87	0.73	0.86	SL
1 1/4x1	9801-168	53.83	20	2.00	2.00	0.73	0.91	SL
1 1/2x1/2	9801-209	56.22	5	1.91	1.93	0.54	1.05	SL
1 1/2x3/4	9801-210	56.22	5	2.00	2.00	0.61	1.05	SL
1 1/2x1	9801-211	56.22	5	2.13	2.20	0.73	0.81	SL
2x1/2	9801-247	64.98	5	2.04	2.19	0.53	1.30	SL
2x3/4	9801-248	64.98	5	2.13	2.31	0.73	1.29	SL
2x1	9801-249	66.98	5	2.25	2.44	0.73	1.26	SL
2x1 1/2	9801-251	66.98	5	2.56	2.69	1.05	1.29	SL
2 1/2x2	9801-292	78.00	5	3.04	3.03	1.28	1.53	SL
3x2	9801-338	136.66	5	3.21	3.40	1.31	1.87	SL
4x2	9801-420	164.09	5	3.52	3.88	1.26	2.37	SL
4x3	9801-422	172.72	5	4.15	4.31	1.87	2.39	SL
6x2	*9801-528FB	551.96	1	6.58	7.21	3.56	5.65	HS
6x3	*9801-530FB	551.96	2	6.58	7.21	3.56	5.26	HS
6x4	9801-532	477.52	2	6.58	6.81	3.49	4.50	HS
8x6	9801-585	876.61	1	7.63	7.59	3.59	4.50	HS

HS = High Strength Design
SL = Slim Line Design

^ = 40% Restock Charge

* = Non-Cancelable / Non-Returnable

Dimensions are subject to change. Please see online "Price Lists" at <http://www.gfpiping.com> for up-to-date information.

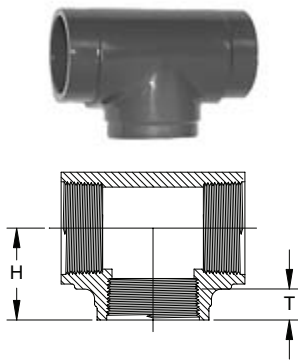

Tee (FPT x FPT x FPT)

Size	Part Number	List \$/ea.	Std. Pack	H	T	Design
1/4	^9805-002	23.27	50	0.92	0.40	HS
3/8	^9805-003	23.27	50	1.16	0.41	HS
1/2	^9805-005	23.27	25	1.27	0.53	HS
3/4	^9805-007	33.52	15	1.38	0.55	HS
1	^9805-010	36.07	15	1.70	0.68	HS
1 1/4	^9805-012	36.30	10	1.93	0.71	HS
1 1/2	^9805-015	38.13	10	2.08	0.72	HS
2	^9805-020	42.32	5	2.35	0.76	HS
2 1/2	^9805-025	201.11	5	2.88	1.14	HS
3	^9805-030	210.98	5	3.50	1.20	HS
4	^9805-040	499.82	5	4.06	1.30	HS

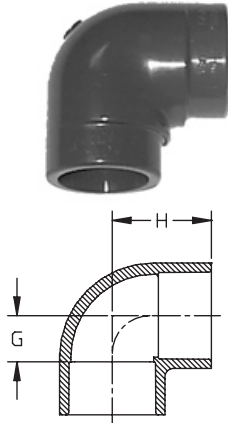

90° Ell (S x S)

Size	Part Number	List \$/ea.	Std. Pack	H	G	Design
1/4	9806-002	11.38	50	0.95	0.33	HS
3/8	9806-003	11.38	50	1.17	0.41	HS
1/2	9806-005	4.46	25	1.41	0.50	SL
3/4	9806-007	5.70	25	1.61	0.56	SL
1	9806-010	9.04	10	1.86	0.69	SL
1 1/4	9806-012	19.58	10	2.17	0.91	SL
1 1/2	9806-015	21.84	10	2.41	1.03	SL
2	9806-020	26.41	5	2.78	1.28	SL
2 1/2	9806-025	60.73	5	3.29	1.51	SL
3	9806-030	68.77	5	3.75	1.85	HS
4	9806-040	123.83	5	4.59	2.34	HS
6	9806-060	248.84	1	6.70	3.51	SL
8	9806-080	608.93	1	8.52	4.47	HS

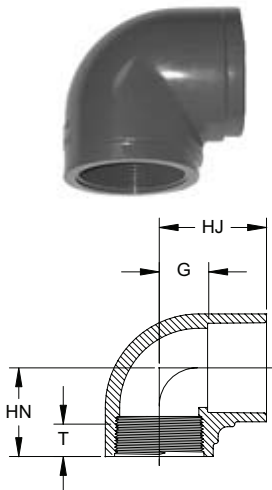

90° Ell (S x FPT)

Size	Part Number	List \$/ea.	Std. Pack	HJ	HN	G	T	Design
1/2	9807-005	11.81	25	1.38	1.28	0.50	0.53	HS
3/4	9807-007	13.86	25	1.57	1.38	0.56	0.55	HS
1	9807-010	18.16	10	1.82	1.70	0.69	0.68	HS

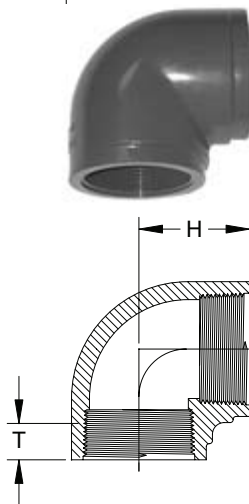

90° Ell (FPT x FPT)

Size	Part Number	List \$/ea.	Std. Pack	H	T	Design
1/4	^9808-002	11.97	50	0.92	0.40	HS
3/8	^9808-003	11.97	50	1.00	0.41	HS
1/2	^9808-005	6.94	25	1.29	0.53	HS
3/4	^9808-007	10.40	20	1.38	0.55	HS
1	^9808-010	14.61	10	1.70	0.68	HS
1 1/4	^9808-012	28.09	10	1.93	0.71	HS
1 1/2	^9808-015	30.26	10	2.06	0.72	HS
2	^9808-020	40.54	5	2.36	0.76	HS
2 1/2	^9808-025	130.90	5	3.00	1.14	HS
3	^9808-030	117.81	5	3.50	1.20	HS
4	^9808-040	215.62	5	4.13	1.30	HS

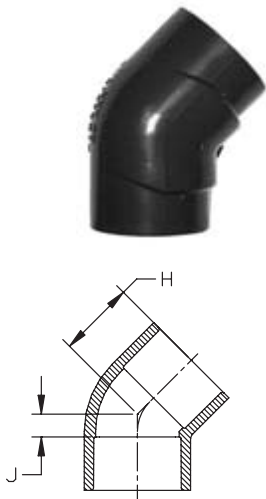

45° Ell (S x S)

Size	Part Number	List \$/ea.	Std. Pack	H	J	Design
1/4	9817-002	16.09	50	0.81	0.13	HS
3/8	9817-003	16.09	50	0.94	0.19	HS
1/2	9817-005	5.46	25	1.21	0.25	SL
3/4	9817-007	7.91	20	1.32	0.33	SL
1	9817-010	12.54	25	1.47	0.29	SL
1 1/4	9817-012	24.64	15	1.70	0.40	SL
1 1/2	9817-015	25.30	25	1.88	0.44	SL
2	9817-020	28.38	5	2.16	0.60	SL
2 1/2	9817-025	58.00	5	2.48	0.65	HS
3	9817-030	74.53	5	2.66	0.78	SL
4	9817-040	102.31	5	3.24	0.95	SL
6	9817-060	315.20	1	4.83	1.73	HS
8	9817-080	655.81	1	6.08	1.98	HS

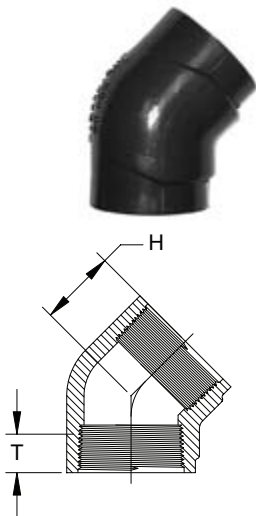

45° Ell (FPT x FPT)

Size	Part Number	List \$/ea.	Std. Pack	H	T	Design
1/4	^9819-002	15.91	50	0.76	0.40	HS
3/8	^9819-003	15.91	50	0.94	0.41	HS
1/2	^9819-005	15.11	25	1.02	0.53	HS
3/4	^9819-007	16.59	20	1.14	0.55	HS
1	^9819-010	18.24	25	1.33	0.68	HS
1 1/4	^9819-012	31.16	15	1.40	0.71	HS
1 1/2	^9819-015	31.16	10	1.52	0.72	HS
2	^9819-020	41.16	5	1.72	0.76	HS
3	^9819-030	114.73	5	2.44	1.20	HS
4	^9819-040	154.30	5	2.77	1.30	HS

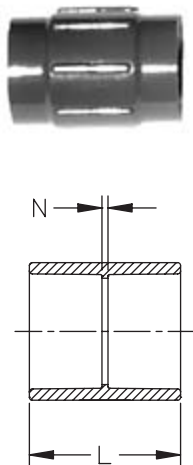

Coupling (S x S)

Size	Part Number	List \$/ea.	Std. Pack	L	N	Design
1/4	9829-002	12.12	50	1.39	0.14	HS
3/8	9829-003	12.12	50	1.64	0.14	HS
1/2	9829-005	4.71	25	1.93	0.13	SL
3/4	9829-007	6.60	20	2.18	0.13	SL
1	9829-010	8.88	25	2.41	0.13	SL
1 1/4	9829-012	13.30	25	2.64	0.12	SL
1 1/2	9829-015	16.76	10	2.90	0.13	SL
2	9829-020	19.47	5	3.14	0.12	SL
2 1/2	9829-025	43.31	5	3.75	0.16	HS
3	9829-030	47.09	5	4.04	0.25	SL
4	9829-040	61.71	5	4.79	0.25	SL
6	9829-060	145.28	2	6.41	0.34	HS
8	9829-080	392.86	2	8.40	0.34	HS

HS = High Strength Design
SL = Slim Line Design

^ = 40% Restock Charge
* = Non-Cancelable / Non-Returnable

Dimensions are subject to change. Please see online "Price Lists" at <http://www.gfpiping.com> for up-to-date information.

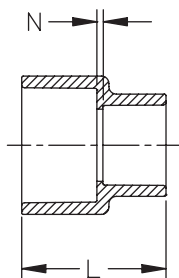

Reducing Coupling (S x S)

Size	Part Number	List \$/ea.	Std. Pack	L	N	Design
3/4 x 1/2	9829-101	12.37	25	2.16	0.14	HS
1 x 1/2	9829-130	17.60	25	2.12	0.09	HS
1 x 3/4	9829-131	17.60	25	2.26	0.12	HS
1 1/2 x 1/2	*9829-209FB	40.86	1	3.34	0.17	HS
1 1/2 x 3/4	*9829-210FB	40.86	1	3.34	0.17	HS
1 1/2 x 1	9829-211	40.00	15	2.66	0.10	HS
1 1/2 x 1 1/4	9829-212	40.00	20	2.82	0.10	HS
2 x 1/2	*9829-247FB	54.03	1	3.35	0.88	HS
2 x 3/4	*9829-248FB	54.03	1	3.36	0.77	HS
2 x 1	9829-249	54.03	5	3.12	0.33	HS
2 x 1 1/4	*9829-250FB	54.03	1	3.37	0.52	HS
2 x 1 1/2	9829-251	52.92	5	3.05	0.10	HS
2 1/2 x 1 1/2	9829-291	61.52	1	3.30	0.13	HS
3 x 2	9829-338	121.66	5	3.61	0.16	HS
4 x 2	*9829-420FB	148.28	1	4.94	1.12	HS
4 x 3	9829-422	145.14	5	4.39	0.26	HS
6 x 4	9829-532	326.77	2	10.25	3.50	HS
8 x 6	9829-585	571.36	2	9.12	2.07	HS

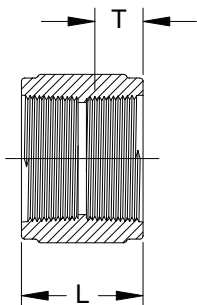

Coupling (FPT x FPT)

Size	Part Number	List \$/ea.	Std. Pack	L	T	Design
1/4	^9830-002	15.24	50	1.30	0.40	HS
3/8	^9830-003	15.24	50	1.34	0.41	HS
1/2	^9830-005	12.54	25	1.66	0.53	HS
3/4	^9830-007	20.28	25	1.73	0.55	HS
1	^9830-010	23.02	25	2.10	0.68	HS
1 1/4	^9830-012	24.17	25	2.19	0.71	HS
1 1/2	^9830-015	26.22	10	2.22	0.72	HS
2	^9830-020	30.91	5	2.29	0.76	HS
3	^9830-030	65.96	5	3.57	1.20	HS
4	^9830-040	134.46	5	3.73	1.30	HS

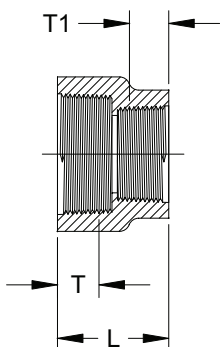

Reducing Coupling (FPTx FPT)

Size	Part Number	List \$/ea.	Std. Pack	L	T	T1	Design
1/2 x 1/4	^9830-072	21.39	50	1.45	0.53	0.40	HS
1/2 x 3/8	^9830-073	21.39	50	1.46	0.53	0.41	HS
3/4 x 1/2	^9830-101	22.92	25	1.69	0.55	0.53	HS
1 x 1/2	^9830-130	22.92	25	1.83	0.68	0.53	HS
1 x 3/4	^9830-131	27.64	25	1.88	0.68	0.55	HS
1 1/2 x 1	^9830-211	53.81	20	1.91	0.71	0.55	HS

Dimensions are subject to change. Please see online "Price Lists" at <http://www.gfpiping.com> for up-to-date information.

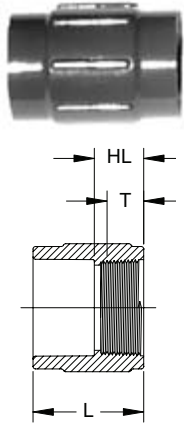

Female Adapter (SxFPT)

Size	Part Number	List \$/ea.	Std. Pack	HL	L	T	Design
1/4	9835-002	15.39	50	0.75	1.43	0.40	HS
1/2	9835-005	7.62	25	0.91	1.79	0.53	HS
3/4	9835-007	8.07	20	0.95	1.96	0.55	HS
1	9835-010	18.62	25	1.11	2.26	0.68	HS
1 1/4	9835-012	19.07	10	1.16	2.44	0.71	HS
1 1/2	9835-015	22.20	10	1.19	2.58	0.72	HS
2	9835-020	38.26	5	1.23	2.74	0.76	HS
3	9835-030	150.60	5	1.91	3.82	1.20	HS
4	9835-040	250.67	5	2.02	4.29	1.30	HS

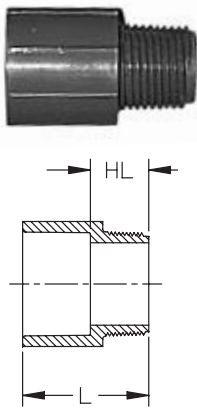

Male Adapter (SxMPT)

Size	Part Number	List \$/ea.	Std. Pack	HL	L	Design
1/2	9836-005	6.10	50	0.98	1.86	HS
3/4	9836-007	7.48	25	1.00	2.04	HS
1	9836-010	12.51	25	1.21	2.39	HS
1 1/4	9836-012	18.46	15	1.29	2.56	HS
1 1/2	9836-015	24.94	15	1.32	2.72	HS
2	9836-020	34.57	5	1.35	2.88	HS
3	9836-030	126.69	5	2.02	3.92	HS
4	9836-040	214.19	1	2.08	4.40	HS

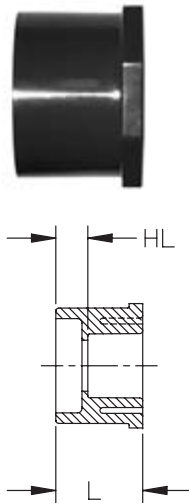

Flush Style Reducer Bushing (SpgxS)

Size	Part Number	List \$/ea.	Std. Pack	HL	L
1/2 x 1/4	9837-072	9.87	50	0.46	1.14
1/2 x 3/8	9837-073	9.87	50	0.32	1.10
3/4 x 1/2	9837-101	5.04	50	0.40	1.29
1 x 1/2	9837-130	7.80	50	0.54	1.42
1 x 3/4	9837-131	7.80	50	0.44	1.42
1 1/4 x 1/2	9837-166	20.77	25	0.66	1.56
1 1/4 x 3/4	9837-167	20.77	25	0.55	1.57
1 1/4 x 1	9837-168	20.77	25	0.42	1.57
1 1/2 x 1/2	9837-209	23.46	25	0.77	1.68
1 1/2 x 3/4	9837-210	23.46	25	0.67	1.69
1 1/2 x 1	9837-211	23.46	25	0.55	1.68
1 1/2 x 1 1/4	9837-212	23.46	25	0.42	1.70
2 x 1/2	9837-247	30.30	10	0.88	1.79
2 x 3/4	9837-248	30.30	25	0.78	1.81
2 x 1	9837-249	30.30	25	0.66	1.81
2 x 1 1/4	9837-250	30.30	10	0.56	1.82
2 x 1 1/2	9837-251	30.30	10	0.40	1.80
2 1/2 x 1 1/2	9837-291	36.87	5	0.96	2.43
2 1/2 x 2	9837-292	36.87	5	0.55	2.13
3 x 1 1/2	9837-337	57.40	5	0.92	2.43
3 x 2	9837-338	56.21	5	0.87	2.43
3 x 2 1/2	9837-339	56.21	5	0.39	2.23
4 x 2	9837-420	62.13	5	1.15	2.72
4 x 3	9837-422	62.13	5	0.77	2.76
6 x 3	9837-530	129.34	2	1.45	3.59
6 x 4	9837-532	132.38	2	2.57	6.92
8 x 6	9837-585	445.13	1	1.56	4.66

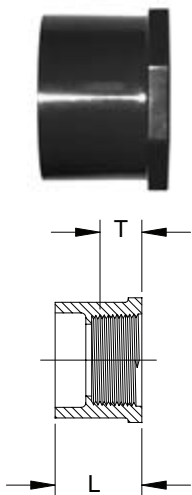

Flush Style Reducer Bushing (SpgxFPT)

Size	Part Number	List \$/ea.	Std. Pack	L	T
1/2 x 1/4	9838-072	10.60	50	1.14	0.40
1/2 x 3/8	9838-073	10.60	50	1.12	0.41
3/4 x 1/4	9838-098	12.08	50	1.21	0.40
3/4 x 1/2	9838-101	5.50	50	1.28	0.53
1 x 1/2	9838-130	6.98	50	1.42	0.53
1 x 3/4	9838-131	6.98	50	1.41	0.55
1 1/4 x 1/2	9838-166	22.48	15	1.53	0.53
1 1/4 x 3/4	9838-167	22.48	15	1.56	0.55
1 1/4 x 1	9838-168	22.48	15	1.55	0.68
1 1/2 x 1/2	9838-209	27.69	15	1.68	0.53
1 1/2 x 3/4	9838-210	27.69	15	1.68	0.55
1 1/2 x 1	9838-211	27.69	15	1.69	0.68
1 1/2 x 1 1/4	9838-212	27.69	25	1.68	0.71
2 x 1/2	9838-247	38.06	10	1.80	0.53
2 x 3/4	9838-248	38.06	10	1.80	0.55
2 x 1	9838-249	38.06	10	1.79	0.68
2 x 1 1/4	9838-250	38.06	10	1.78	0.71
2 x 1 1/2	9838-251	38.06	10	1.79	0.72
2 1/2 x 1 1/2	9838-291	60.47	5	2.11	0.72
2 1/2 x 2	9838-292	60.47	5	2.20	0.76
3 x 2	9838-338	134.81	5	2.44	0.76
4 x 2	9838-420	274.67	5	2.73	0.76
4 x 3	9838-422	274.67	5	2.75	0.38

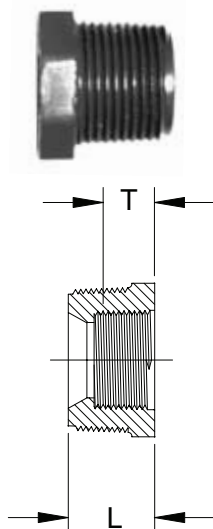

Flush Style Reducer Bushing (MPTxFPT)

Size	Part Number	List \$/ea.	Std. Pack	L	T
3/8 x 1/4	^9839-052	14.56	50	0.79	0.40
1/2 x 1/4	^9839-072	14.56	50	0.96	0.40
1/2 x 3/8	^9839-073	6.89	50	0.94	0.41
3/4 x 3/8	^9839-099	6.89	50	1.02	0.41
3/4 x 1/2	^9839-101	11.63	50	1.08	0.53
1 x 1/2	^9839-130	11.63	25	1.24	0.53
1 x 3/4	^9839-131	22.90	50	1.27	0.55
1 1/4 x 1	^9839-168	27.79	25	1.30	0.68
1 1/2 x 3/4	^9839-210	27.79	25	1.33	0.55
1 1/2 x 1	^9839-211	27.58	50	1.34	0.68
1 1/2 x 1 1/4	^9839-212	27.58	10	1.32	0.71
2 x 1	^9839-249	29.61	10	1.43	0.68
2 x 1 1/4	^9839-250	30.74	10	1.43	0.71
2 x 1 1/2	^9839-251	27.58	10	1.35	0.72

^ = 40% Restock Charge

* = Non-Cancelable / Non-Returnable

Dimensions are subject to change. Please see online "Price Lists" at <http://www.gfpiping.com> for up-to-date information.

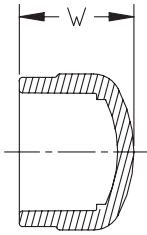

Cap (S)

Size	Part Number	List \$/ea.	Std. Pack	W	Design
1/2	9847-005	7.38	50	1.29	HS
3/4	9847-007	10.48	25	1.46	HS
1	9847-010	18.53	25	1.67	HS
1 1/4	9847-012	20.28	15	1.88	HS
1 1/2	9847-015	20.28	10	2.09	HS
2	9847-020	21.38	5	2.32	HS
2 1/2	9847-025	71.96	5	2.73	HS
3	9847-030	78.90	5	3.05	HS
4	9847-040	80.20	5	3.67	HS
6	9847-060	265.36	2	4.96	HS
8	9847-080	805.29	2	7.02	HS

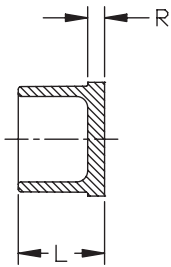

Plug (Spg)

Size	Part Number	List \$/ea.	Std. Pack	L	R
1/2	9849-005	6.55	50	1.09	0.20
3/4					
1					
1 1/2					
2					
4					

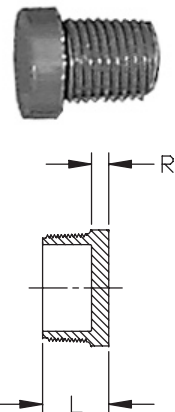
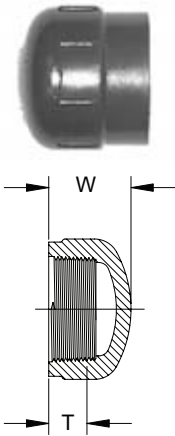

Cap (FPT)

Size	Part Number	List \$/ea.	Std. Pack	W	T	Design
1/4	^9848-002	9.51	50	0.93	0.40	HS
3/8	^9848-003	9.51	50	0.95	0.41	HS
1/2	^9848-005	8.16	50	1.16	0.53	HS
3/4	^9848-007	13.54	25	1.24	0.55	HS
1	^9848-010	18.92	25	1.50	0.68	HS
1 1/4	^9848-012	33.73	15	1.61	0.71	HS
1 1/2	^9848-015	34.60	10	1.66	0.72	HS
2	^9848-020	49.78	5	1.84	0.76	HS

Plug (MPT)

Size	Part Number	List \$/ea.	Std. Pack	L	R
1/4	9850-002	7.63	50	0.81	0.22
3/8	9850-003	7.63	50	0.83	0.22
1/2	9850-005	6.63	50	0.97	0.22
3/4	9850-007	8.42	50	1.04	0.25
1	9850-010	13.82	25	1.25	0.27
1 1/2	9850-015	17.33	20	1.38	0.34
2	9850-020	23.60	10	1.46	0.40
2 1/2	9850-025	40.10	10	2.00	0.38
3	9850-030	43.82	5	2.00	0.38
4	9850-040	50.76	5	2.15	0.39

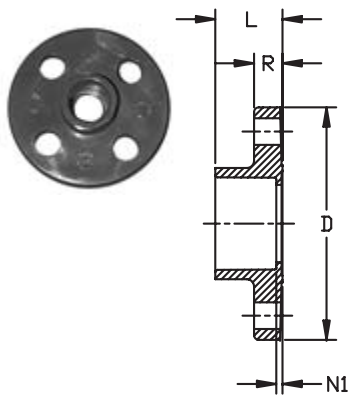

Flange (S)

Size	Part Number	List \$/ea.	Std. Pack	# of Holes	Bolt Dia.	Bolt Circle Dia.	D	L	N1	R
1/2	9851-005	19.86	5	4	1/2	2.38	3.50	1.03	0.15	0.43
3/4	9851-007	20.34	5	4	1/2	2.75	3.88	1.21	0.19	0.44
1	9851-010	22.21	5	4	1/2	3.13	4.25	1.28	0.15	0.57
1 1/4	9851-012	27.09	5	4	1/2	3.50	4.63	1.42	0.16	0.56
1 1/2	9851-015	30.08	5	4	1/2	3.88	5.00	1.54	0.16	0.71
2	9851-020	36.41	5	4	5/8	4.75	6.00	1.77	0.16	0.74
2 1/2	9851-025	75.43	5	4	5/8	5.50	7.00	2.01	0.19	0.89
3	9851-030	78.90	5	4	5/8	6.00	7.50	2.20	0.31	1.12
4	9851-040	106.59	5	8	5/8	7.50	9.00	2.55	0.22	1.27
6	9851-060	181.56	1	8	3/4	9.50	11.00	3.86	0.34	1.45

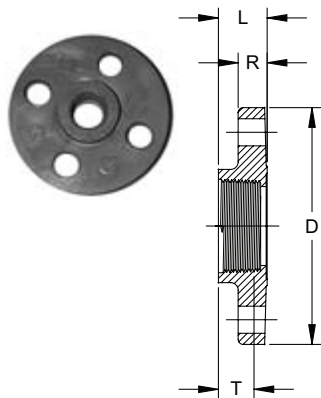

Flange (FPT)

Size	Part Number	List \$/ea.	Std. Pack	# of Holes	Bolt Dia.	Bolt Circle Dia.	D	L	T	R
1/2	^9852-005	27.77	5	4	1/2	2.38	3.50	0.94	0.53	0.44
3/4	^9852-007	33.70	5	4	1/2	2.75	3.88	0.95	0.55	0.51
1	^9852-010	36.78	5	4	1/2	3.13	4.25	1.13	0.68	0.55
1 1/4	^9852-012	50.00	5	4	1/2	3.50	4.63	1.19	0.71	0.63
1 1/2	^9852-015	54.02	5	4	1/2	3.88	5.00	1.21	0.72	0.72
2	^9852-020	55.01	5	4	5/8	4.75	6.00	1.23	0.76	0.75
3	^9852-030	88.59	5	4	5/8	6.00	7.50	1.88	1.20	0.98
4	^9852-040	137.73	5	8	5/8	7.50	9.00	1.99	1.30	1.24

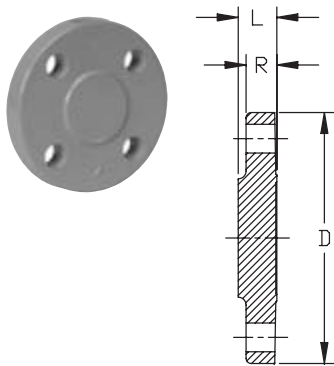

Flange (Blind)

Size	Part Number	List \$/ea.	Std. Pack	# of Holes	Bolt Dia.	Bolt Circle Dia.	D	L	R
1/2	9853-005	30.43	5	4	1/2	2.38	3.50	0.50	0.43
3/4	9853-007	33.00	5	4	1/2	2.75	3.88	0.50	0.44
1	9853-010	41.13	5	4	1/2	3.13	4.25	0.60	0.57
1 1/4	9853-012	46.54	5	4	1/2	3.50	4.63	0.63	0.56
1 1/2	9853-015	63.76	5	4	1/2	3.88	5.00	0.82	0.71
2	9853-020	66.99	5	4	5/8	4.75	6.00	0.92	0.74
3	9853-030	100.53	5	4	5/8	6.00	7.50	1.03	0.89
4	9853-040	170.63	5	8	5/8	7.50	9.00	1.35	1.12
6	9853-060	292.36	1	8	3/4	9.50	11.00	1.49	1.27
8	9853-080	542.32	1	8	3/4	11.75	13.50	1.63	1.45

^ = 40% Restock Charge

* = Non-Cancelable / Non-Returnable

Dimensions are subject to change. Please see online "Price Lists" at <http://www.gfpiping.com> for up-to-date information.

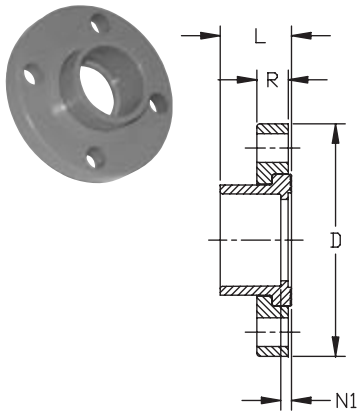

Van Stone Flange (S)

Size	Part Number	List \$/ea.	Std. Pack	# of Holes	Bolt Dia.	Bolt Circle Dia.	D	L	N1	R
1/2	9854-005	20.01	5	4	1/2	2.38	3.50	1.03	0.11	0.57
3/4	9854-007	20.44	5	4	1/2	2.75	3.88	1.15	0.13	0.58
1	9854-010	22.34	5	4	1/2	3.13	4.25	1.39	0.13	0.66
1 1/4	9854-012	27.28	5	4	1/2	3.50	4.63	1.45	0.14	0.69
1 1/2	9854-015	30.30	5	4	1/2	3.88	5.00	1.59	0.15	0.76
2	9854-020	36.66	5	4	5/8	4.75	6.00	1.76	0.20	0.82
2 1/2	9854-025	75.97	5	4	5/8	5.50	7.00	2.05	0.22	0.98
3	9854-030	79.54	5	4	5/8	6.00	7.50	2.25	0.30	1.02
4	9854-040	107.43	5	8	5/8	7.50	9.00	2.65	0.34	1.11
6	9854-060	183.04	1	8	3/4	9.50	11.00	3.45	0.35	1.37
8	9854-080	550.78	1	8	3/4	11.75	13.50	4.50	0.40	1.73

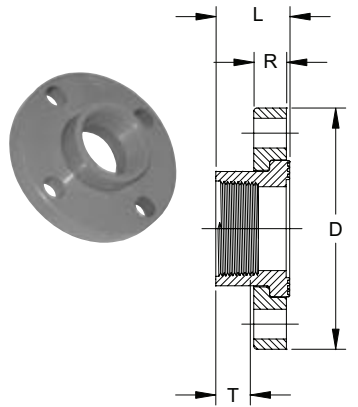

Van Stone Flange (FPT)

Size	Part Number	List \$/ea.	Std. Pack	# of Holes	Bolt Dia.	Bolt Circle Dia.	D	L	T	R
1	^9855-010	37.03	5	4	1/2	3.13	4.25	1.38	0.68	0.66
1 1/4	^9855-012	50.97	5	4	1/2	3.50	4.63	1.49	0.71	0.69
1 1/2	^9855-015	54.40	5	4	1/2	3.88	5.00	1.61	0.72	0.76
2	^9855-020	55.41	5	4	5/8	4.75	6.00	1.75	0.76	0.82

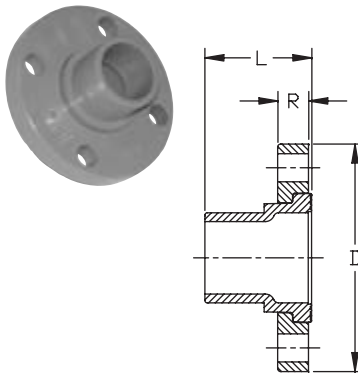

Van Stone Flange (Spg)

Size	Part Number	List \$/ea.	Std. Pack	# of Holes	Bolt Dia.	Bolt Circle Dia.	D	L	R
1/2	9856-005	23.14	5	4	1/2	2.38	3.50	1.65	0.57
3/4	9856-007	24.82	5	4	1/2	2.75	3.88	1.78	0.58
1	9856-010	28.20	5	4	1/2	3.13	4.25	2.02	0.66
1 1/4	9856-012	34.89	5	4	1/2	3.50	4.63	2.20	0.69
1 1/2	9856-015	38.60	5	4	1/2	3.88	5.00	2.40	0.76
2	9856-020	54.02	5	4	5/8	4.75	6.00	2.72	0.82
2 1/2	9856-025	80.34	5	4	5/8	5.50	7.00	3.19	0.98
3	9856-030	87.99	5	4	5/8	6.00	7.50	3.52	1.02
4	9856-040	90.54	5	8	5/8	7.50	9.00	4.02	1.11

^ = 40% Restock Charge

* = Non-Cancelable / Non-Returnable

Dimensions are subject to change. Please see online "Price Lists" at <http://www.gfpiping.com> for up-to-date information.

Nipple (MPT x MPT)

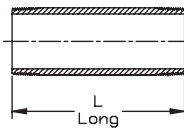
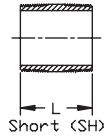
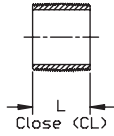

Size	Part Number	List \$/ea.	Std. Pack	L
1/2 x CL	*9861-077	3.18	50	1.13
1/2 x SH	*9861-015	2.82	50	1.13
1/2 x 2	*9861-079	6.06	50	2.00
1/2 x 3	*9861-081	5.22	50	3.00
1/2 x 4	*9861-082	5.19	50	4.00
1/2 x 5	*9861-083	6.04	50	5.00
1/2 x 6	*9861-084	11.06	50	6.00
3/4 x CL	*9861-104	5.69	25	1.38
3/4 x 2	*9861-020	4.08	25	2.00
3/4 x 3	*9861-106	11.81	25	3.00
3/4 x 4	*9861-107	6.56	25	4.00
3/4 x 5	*9861-108	7.79	25	5.00
3/4 x 6	*9861-109	23.84	25	6.00
1 x CL	*9861-133	9.11	25	1.50
1 x SH	*9861-134	11.81	25	2.00
1 x 3	*9861-135	7.17	25	3.00
1 x 4	*9861-136	9.70	25	4.00
1 x 5	*9861-137	10.87	25	5.00
1 x 6	*9861-138	35.10	25	6.00
1 1/4 x CL	*9861-170	6.56	25	1.63
1 1/4 x SH	*9861-171	16.48	25	2.50
1 1/4 x 3	*9861-172	9.63	25	3.00
1 1/4 x 4	*9861-173	11.98	25	4.00
1 1/4 x 5	*9861-174	14.46	25	5.00
1 1/4 x 6	*9861-175	16.93	25	6.00
1 1/2 x CL	*9861-213	17.60	25	1.75
1 1/2 x SH	*9861-214	19.96	25	2.50
1 1/2 x 3	*9861-215	10.62	25	3.00
1 1/2 x 4	*9861-216	22.10	25	4.00
1 1/2 x 5	*9861-217	16.06	25	5.00
1 1/2 x 6	*9861-218	58.68	25	6.00
2 x CL	*9861-251	26.63	25	2.00
2 x SH	*9861-252	33.00	25	2.50
2 x 3	*9861-253	39.18	25	3.00
2 x 4	*9861-254	18.29	25	4.00
2 x 5	*9861-255	21.99	25	5.00
2 x 6	*9861-256	58.72	25	6.00
2 1/2 x CL	*9861-291	20.01	5	2.50
2 1/2 x SH	*9861-292	20.13	5	3.00
2 1/2 x 4	*9861-295	28.54	5	4.00
2 1/2 x 5	*9861-296	34.22	5	5.00
2 1/2 x 6	*9861-297	40.64	5	6.00
3 x CL	*9861-338	28.18	5	2.63
3 x SH	*9861-340	28.67	5	3.00
3 x 4	*9861-341	35.09	5	4.00
3 x 5	*9861-342	43.74	5	5.00
3 x 6	*9861-343	18.68	5	6.00
4 x CL	*9861-422	39.54	5	2.88
4 x SH	*9861-423	50.90	5	4.00
4 x 5	*9861-425	62.14	5	5.00
4 x 6	*9861-426	74.38	5	6.00

^ = 40% Restock Charge

* = Non-Cancelable / Non-Returnable

Dimensions are subject to change. Please see online "Price Lists" at <http://www.gfpiping.com> for up-to-date information.

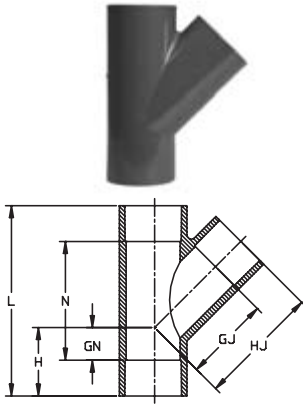

45° Wye (SxSxS)

Size	Part Number	List \$/ea.	Std. Pack	GJ	GN	H	HJ	L	N	Design
1½	*9870-015	45.98	20	2.56	0.47	1.47	1.97	5.81	2.59	HS
2	*9870-020	131.91	10	3.19	0.63	2.13	4.69	6.88	3.19	HS
3	9870-030	424.10	4	5.00	1.66	3.55	6.88	10.43	6.63	SL
4	9870-040	448.50	4	6.38	1.84	4.20	8.75	12.96	8.25	SL
6	9870-060	613.75	2	8.50	1.81	4.86	11.59	16.50	10.39	HS
6 x 4	9870-532	480.00	1	7.18	1.87	4.91	9.45	16.50	10.39	HS

Rated 150psi at 73°F

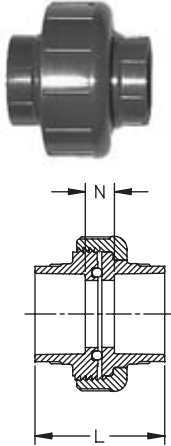

Union (SxS)

Size	Part Number	List \$/ea.	Std. Pack	L	N
¼	9897-002	30.07	25	1.61	0.76
⅜	9897-003	30.07	25	1.91	0.77
½	9897-005	20.19	25	2.31	0.95
¾	9897-007	20.91	5	2.58	1.08
1	9897-010	25.03	5	2.89	1.25
1¼	9897-012	50.73	5	3.23	1.32
1½	9897-015	51.68	5	3.44	1.32
2	9897-020	85.63	2	3.77	1.51
3	9897-030	177.76	1	4.74	2.00
4	9897-040	232.20	1	5.62	2.05

O-Ring Material: EPDM

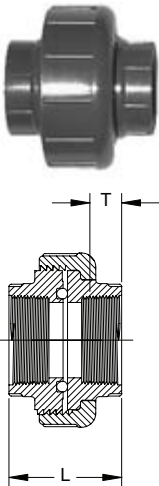

Union (FPTxFPT)

Size	Part Number	List \$/ea.	Std. Pack	L	T
⅜	^9898-003	33.81	25	1.58	0.41
½	^9898-005	21.42	25	2.03	0.53
¾	^9898-007	37.86	5	2.11	0.55
1	^9898-010	52.20	5	2.56	0.68
1¼	^9898-012	99.47	5	2.79	0.71
1½	^9898-015	99.47	5	2.72	0.72
2	^9898-020	112.44	2	2.89	0.76
3	^9898-030	356.26	1	4.69	1.20
4	^9898-040	374.86	1	5.62	1.30

O-Ring Material: EPDM

HS = High Strength Design
SL = Slim Line Design

^ = 40% Restock Charge
* = Non-Cancelable / Non-Returnable

Dimensions are subject to change. Please see online "Price Lists" at <http://www.gfpiping.com> for up-to-date information.

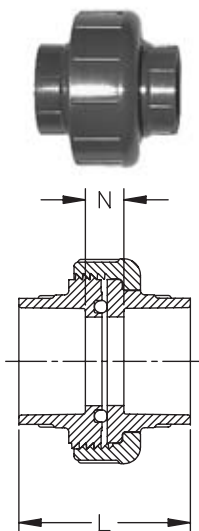

Union (SxS)

Size	Part Number	List \$/ea.	Std. Pack	L	N
1/4	9857-002	30.44	25	1.61	0.76
3/8	9857-003	30.44	25	1.91	0.77
1/2	9857-005	20.23	25	2.31	0.95
3/4	9857-007	21.17	5	2.58	1.08
1	9857-010	25.38	5	2.89	1.25
1 1/4	9857-012	51.37	5	3.23	1.32
1 1/2	9857-015	52.31	5	3.44	1.32
2	9857-020	86.71	2	3.77	1.51
3	9857-030	179.97	1	4.74	2.00
4	9857-040	234.87	1	5.62	2.05

O-Ring Material: FPM

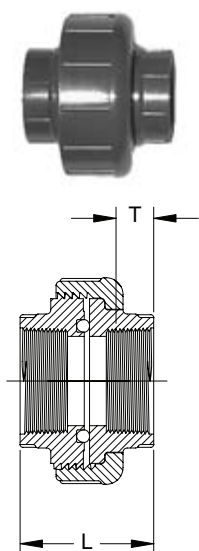

Union (FPTxFPT)

Size	Part Number	List \$/ea.	Std. Pack	L	T
3/8	^9858-003	34.22	25	1.58	0.41
1/2	^9858-005	21.71	25	2.03	0.53
3/4	^9858-007	38.34	5	2.11	0.55
1	^9858-010	52.86	5	2.56	0.68
1 1/4	^9858-012	100.71	5	2.79	0.71
1 1/2	^9858-015	100.71	5	2.72	0.72
2	^9858-020	113.84	2	2.89	0.76
3	^9858-030	360.58	1	4.69	1.20
4	^9858-040	382.07	1	5.62	1.30

O-Ring Material: FPM

^ = 40% Restock Charge

* = Non-Cancelable / Non-Returnable

Dimensions are subject to change. Please see online "Price Lists" at <http://www.gfpiping.com> for up-to-date information.

Schedule 80 CPVC Expansion Joint

P/L 34 : CPVC Pressure Expansion Joint

Flanged, spigot and threaded ends available. Contact factory for pricing and availability.

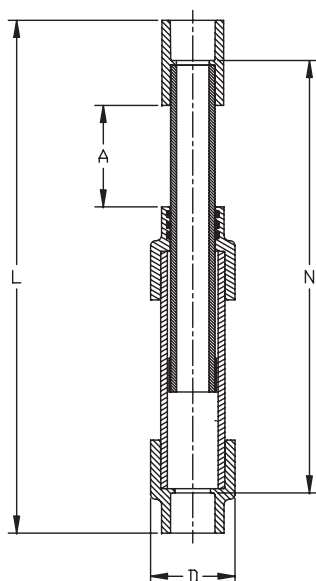

Expansion Joint 6" Travel (SxS)

Size	Part Number	List \$/ea.	Std. Pack	A	D	L	N
1/2	*9826-005X6	223.69	1	3.00	1.85	13.93	12.06
3/4	*9826-007X6	245.61	1	3.00	2.23	14.40	12.46
1	*9826-010X6	311.34	1	3.00	2.50	15.02	12.58
1 1/4	*9826-012X6	302.92	1	3.00	2.50	15.81	13.05
1 1/2	*9826-015X6	383.74	1	3.00	3.50	16.08	13.13
2	*9826-020X6	501.68	1	3.00	4.39	18.10	14.88
3	*9826-030X6	529.07	1	3.00	5.53	19.83	15.79
4	*9826-040X6	838.77	1	3.00	7.93	27.56	23.01
6	*9826-060X6	991.40	1	3.00	9.97	27.88	21.75

O-Ring Material: EPDM

Expansion Joint 12" Travel (SxS)

Size	Part Number	List \$/ea.	Std. Pack	A	D	L	N
1/2	*9826-005X12	227.78	1	6.00	1.85	22.93	21.06
3/4	*9826-007X12	261.23	1	6.00	2.23	23.40	21.46
1	*9826-010X12	278.71	1	6.00	2.50	24.02	21.58
1 1/4	*9826-012X12	349.82	1	6.00	2.50	24.81	22.05
1 1/2	*9826-015X12	441.81	1	6.00	3.50	25.08	22.13
2	*9826-020X12	446.54	1	6.00	4.39	27.10	23.88
3	*9826-030X12	543.28	1	6.00	5.53	28.83	24.79
4	*9826-040X12	899.94	1	6.00	7.93	36.56	32.01
6	*9826-060X12	991.29	1	6.00	9.97	36.88	30.75

O-Ring Material: EPDM

Expansion Joint 6" Travel (SxS)

Size	Part Number	List \$/ea.	Std. Pack	A	D	L	N
1/2	*9836-005X6	263.16	1	3.00	1.85	13.93	12.06
3/4	*9836-007X6	287.96	1	3.00	2.23	14.40	12.46
1	*9836-010X6	311.30	1	3.00	2.50	15.02	12.58
1 1/4	*9836-012X6	356.38	1	3.00	2.50	15.81	13.05
1 1/2	*9836-015X6	451.52	1	3.00	3.50	16.08	13.13
2	*9836-020X6	474.86	1	3.00	4.39	18.10	14.88
3	*9836-030X6	622.46	1	3.00	5.53	19.83	15.79
4	*9836-040X6	986.82	1	3.00	7.93	27.56	23.01
6	*9836-060X6	1,080.10	1	3.00	9.97	27.88	21.75

O-Ring Material: FPM

Expansion Joint 12" Travel (SxS)

Size	Part Number	List \$/ea.	Std. Pack	A	D	L	N
1/2	*9836-005X12	268.01	1	6.00	1.85	22.93	21.06
3/4	*9836-007X12	307.37	1	6.00	2.23	23.40	21.46
1	*9836-010X12	327.90	1	6.00	2.50	24.02	21.58
1 1/4	*9836-012X12	411.58	1	6.00	2.50	24.81	22.05
1 1/2	*9836-015X12	519.77	1	6.00	3.50	25.08	22.13
2	*9836-020X12	525.32	1	6.00	4.39	27.10	23.88
3	*9836-030X12	639.18	1	6.00	5.53	28.83	24.79
4	*9836-040X12	1,058.77	1	6.00	7.93	36.56	32.01
6	*9836-060X12	1,166.38	1	6.00	9.97	36.88	30.75

O-Ring Material: FPM

^ = 40% Restock Charge
 * = Non-Cancelable / Non-Returnable

Schedule 80 CPVC Brass Insert Fittings

P/L 33 : CPVC Pressure Brass Insert Fittings

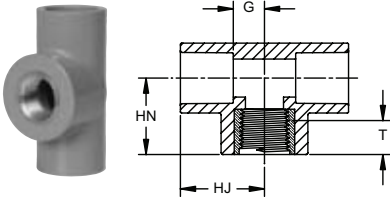

Tee (SxSxFPT Brass)

Size	Part Number	List \$/ea.	Std. Pack	HJ	HN	G	T
1/2	*8120200806	26.90	20	1.44	1.09	0.53	0.53
3/4 x 1/2	*8120200837	33.39	20	1.63	1.19	0.59	0.53

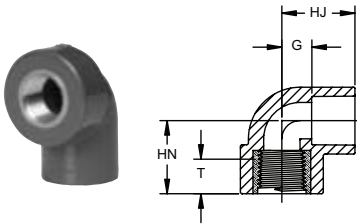

90° Ell (S x FPT Brass)

Size	Part Number	List \$/ea.	Std. Pack	HJ	HN	G	T
1/2	*8120100806	23.69	20	1.44	1.09	0.53	0.53
3/4 x 1/2	*8120100837	29.64	20	1.63	1.19	0.59	0.53

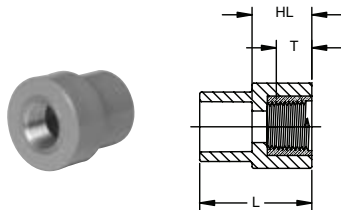

Coupling (SxFPT Brass)

Size	Part Number	List \$/ea.	Std. Pack	HL	L	T
1/2	*8120910806	14.62	20	0.93	1.66	0.53
3/4 x 1/2	*8120910837	21.17	20	0.86	1.78	0.53

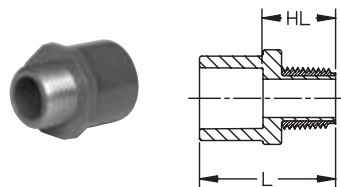

Male Adapter (SxMPT Brass)

Size	Part Number	List \$/ea.	Std. Pack	HL	L
1/2	*8120900806	14.62	25	0.92	1.65
3/4	*8120900807	30.23	15	0.93	1.85
1	*8120900808	53.04	15	1.02	2.05

^ = 40% Restock Charge

* = Non-Cancelable / Non-Returnable

Dimensions are subject to change. Please see online "Price Lists" at <http://www.gfpiping.com> for up-to-date information.

Schedule 80 CPVC

Schedule 80 CPVC Large Diameter Fittings

P/L 02 : CPVC Pressure LD Fittings - Molded

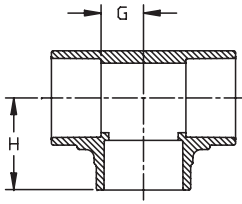

Tee (SxSxS)

Size	Part Number	List \$/ea.	Std. Pack	H	G
10	9801-100	1,280.50	1	10.85	5.75
12	9801-120	1,990.25	1	13.39	6.89

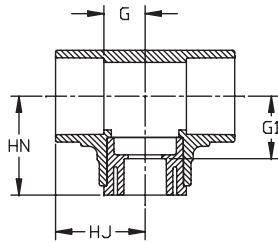

Reducing Tee (SxSxS)

Size	Part Number	List \$/ea.	Std. Pack	HJ	HN	G	G1
10 x 8	*9801-628FB	2,102.82	1	10.85	11.41	5.75	7.32
12 x 10	*9801-670FB	3,364.92	1	13.39	13.61	6.89	8.52

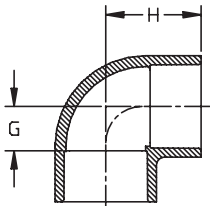

90° Ell (SxS)

Size	Part Number	List \$/ea.	Std. Pack	H	G
10	9806-100	1187.50	1	10.70	5.67
12	9806-120	1606.50	1	13.39	6.89

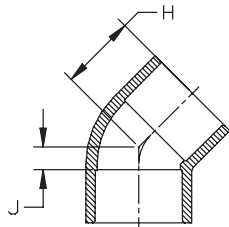

45° Ell (SxS)

Size	Part Number	List \$/ea.	Std. Pack	H	J
10	9817-100	908.00	1	8.11	2.61
12	9817-120	1597.50	1	9.58	3.08

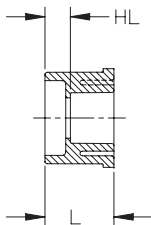

Flush Style Reducer Bushing (SpgxS)

Size	Part Number	List \$/ea.	Std. Pack	HL	L
10 x 8	9837-628	564.21	1	1.57	5.66
12 x 10	9837-670	710.17	1	1.63	6.72

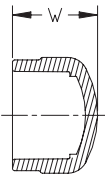

Cap (S)

Size	Part Number	List \$/ea.	Std. Pack	W
10	9847-100	491.00	1	7.88
12	9847-120	538.00	1	9.38

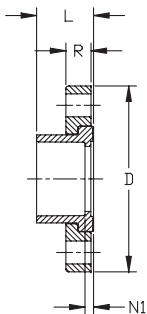

Van Stone Flange (S)

Size	Part Number	List \$/ea.	Std. Pack	# of Holes	Bolt Dia.	Bolt Circle Dia.	D	L	N1	R
10	9854-100	823.45	1	12	7/8	14.25	16.00	5.63	0.50	1.73
12	9854-120	1,193.25	1	12	7/8	17.00	19.00	6.69	0.56	1.73

Schedule 80 CPVC Large Diameter Fittings

P/L 06 : CPVC Pressure LD Fittings - Fabricated

Reducing Tee (SxSxS)

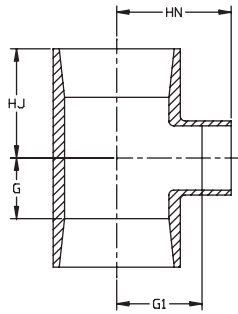

Size	Part Number	List \$/ea.	Std. Pack	HJ	HN	G	G1
10 x 2	*9801-619H	1,419.02	1	9.69	14.50	4.69	13.31
10 x 3	*9801-621H	1,549.61	1	10.25	15.00	5.25	13.25
10 x 4	*9801-623H	1,638.61	1	10.75	15.50	5.75	13.25
10 x 6	*9801-626H	1,842.39	1	11.81	16.50	6.81	13.19
12 x 2	*9801-659H	1,893.49	1	10.69	16.50	4.69	15.31
12 x 3	*9801-661H	2,139.59	1	11.25	17.00	5.25	15.25
12 x 4	*9801-663H	2,385.66	1	11.75	17.50	5.75	15.25
12 x 6	*9801-666H	2,628.39	1	12.81	18.50	6.81	15.19
12 x 8	*9801-668H	2,732.67	1	13.81	19.75	7.81	15.44

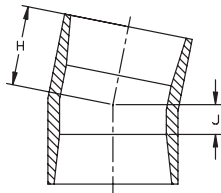

11¼° Ell (SxS)

Size	Part Number	List \$/ea.	Std. Pack	H	J
10	*9811-100H	995.17	1	10.81	5.81
12	*9811-120H	1,503.67	1	11.88	5.88

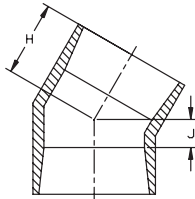

30° Ell (SxS)

Size	Part Number	List \$/ea.	Std. Pack	H	J
10	*9815-100H	1,054.24	1	12.25	7.25
12	*9815-120H	1,655.98	1	13.50	7.50

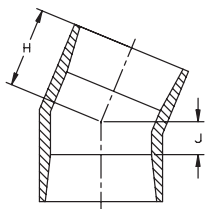

22½° Ell (SxS)

Size	Part Number	List \$/ea.	Std. Pack	H	J
10	*9816-100H	995.17	1	11.63	6.63
12	*9816-120H	1,503.67	1	12.88	6.88

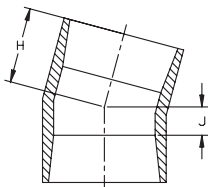

15° Ell (SxS)

Size	Part Number	List \$/ea.	Std. Pack	H	J
10	*9818-100H	1,195.34	1	11.38	6.38
12	*9818-120H	1,468.14	1	12.38	6.38

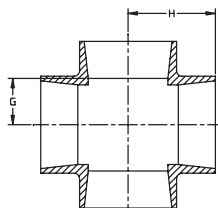

Cross (SxSxS)

Size	Part Number	List \$/ea.	Std. Pack	H	J
10	*9820-100H	2,363.88	1	19.25	8.88
12	*9820-120H	2,761.03	1	22.25	9.88

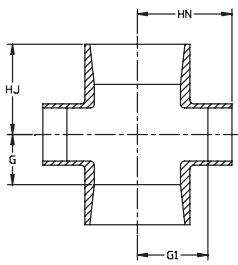

Reducing Cross (SxSxSxS)

Size	Part Number	List \$/ea.	Std. Pack	HJ	HN	G	G1
10 x 2	*9820-619H	1,309.54	1	9.69	14.50	4.69	13.31
10 x 3	*9820-621H	1,453.35	1	10.25	15.00	5.25	13.25
10 x 4	*9820-623H	1,787.61	1	10.75	15.50	5.75	13.25
10 x 6	*9820-626H	2,091.32	1	11.81	16.50	6.81	13.19
10 x 8	*9820-628H	2,508.33	1	12.81	17.75	7.81	13.44
12 x 2	*9820-659H	1,629.23	1	10.69	16.50	4.69	15.31
12 x 3	*9820-661H	1,798.82	1	11.25	17.00	5.25	15.25
12 x 4	*9820-663H	2,475.04	1	11.75	17.50	5.75	15.25
12 x 6	*9820-666H	2,817.68	1	12.81	18.50	6.81	15.19
12 x 8	*9820-668H	3,273.61	1	13.81	19.75	7.81	15.44
12 x 10	*9820-670H	4,147.96	1	14.88	21.25	8.88	15.88

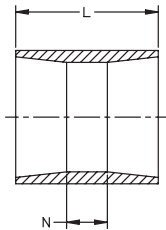

Coupling (SxS)

Size	Part Number	List \$/ea.	Std. Pack	L	N
10	*9829-100H	785.56	1	13.00	3.00
12	*9829-120H	1,289.48	1	15.00	3.00

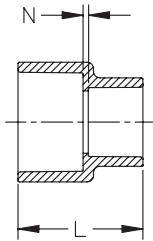

Reducing Coupling (SxS)

Size	Part Number	List \$/ea.	Std. Pack	L	N
10 x 4	*9829-623H	785.56	1	16.25	9.25
10 x 6	*9829-626H	701.60	1	15.75	7.75
10 x 8	*9829-628H	431.28	1	14.00	5.00
12 x 8	*9829-668H	1,310.46	1	17.00	7.00
12 x 10	*9829-670H	1,094.20	1	17.00	6.00

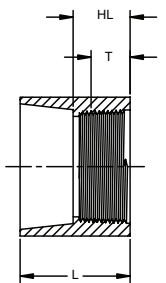

Female Adapter (SxFPT)

Size	Part Number	List \$/ea.	Std. Pack	HL	L	T
6	*9835-060H	551.08	1	4.50	7.50	1.51
8	*9835-080H	598.99	1	4.25	8.50	1.71
10	*9835-100H	752.55	1	5.00	10.00	1.93
12	*9835-120H	900.88	1	5.00	11.00	2.13

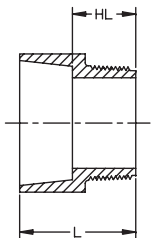

Male Adapter (SxMPT)

Size	Part Number	List \$/ea.	Std. Pack	HL	L
6	*9836-060H	455.24	1	3.50	7.00
8	*9836-080H	517.53	1	4.00	8.00
10	*9836-100H	613.37	1	4.50	9.50
12	*9836-120H	673.08	1	5.50	11.50

^ = 40% Restock Charge

* = Non-Cancelable / Non-Returnable

Dimensions are subject to change. Please see online "Price Lists" at <http://www.gfpiping.com> for up-to-date information.

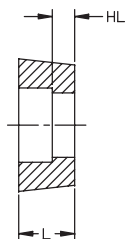

Flush Style Reducer Bushing (SpgxS)

Size	Part Number	List \$/ea.	Std. Pack	HL	L
10 x 4	*9837-623H	1,413.62	1	3.00	5.00
10 x 6	*9837-626H	698.21	1	2.00	5.00
12 x 6	*9837-666H	1,884.55	1	3.00	5.00
12 x 8	*9837-668H	880.17	1	2.00	6.00

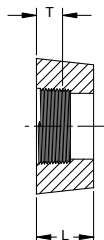

Flush Style Reducer Bushing (SpgxFPT)

Size	Part Number	List \$/ea.	Std. Pack	L	T
10 x 6	*9838-626H	1,996.10	1	5.00	1.51
10 x 8	*9838-628H	1,131.12	1	5.00	1.71
12 x 8	*9838-668H	2,342.08	1	6.00	1.71
12 x 10	*9838-670H	2,108.30	1	6.00	1.93

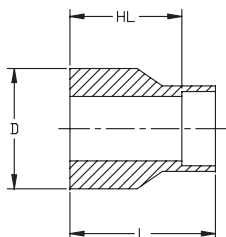

Extended Style Reducer Bushing (SpgxS)

Size	Part Number	List \$/ea.	Std. Pack	D	HL	L
10 x 6	*9840-626H	1,389.66	1	10.75	9.00	12.00
10 x 8	*9840-628H	891.29	1	10.75	6.50	10.50
12 x 8	*9840-668H	1,916.77	1	12.75	10.00	15.00
12 x 10	*9840-670H	1,030.27	1	12.75	7.25	12.25

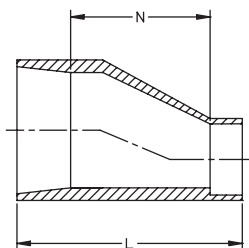

Eccentric Reducer (SxS)

Size	Part Number	List \$/ea.	Std. Pack	L	N
10 x 4	*9841-623H	1,832.22	1	24.25	17.00
10 x 6	*9841-626H	1,775.84	1	15.25	7.25
10 x 8	*9841-628H	1,629.26	1	18.00	9.00
12 x 6	*9841-666H	1,758.90	1	24.00	9.25
12 x 8	*9841-668H	1,905.53	1	24.25	8.00
12 x 10	*9841-670H	2,001.37	1	21.00	3.25

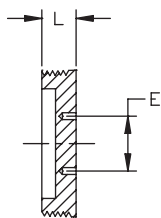

Plug (MPT)

Size	Part Number	List \$/ea.	Std. Pack	E	L
6	*9850-060H	383.35	1	4.00	1.00
8	*9850-080H	402.53	1	4.00	1.00
10	*9850-100H	426.48	1	4.00	1.00
12	*9850-120H	455.24	1	4.00	1.00

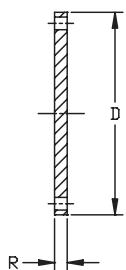

Flange (Blind)

Size	Part Number	List \$/ea.	Std. Pack	# of Holes	Bolt Dia.	Bolt Corcle Dia.	D	R
10	*9853-100H	866.61	1	12	7/8	14.25	16.00	1.00
12	*9853-120H	1,455.90	1	12	7/8	17.00	19.00	1.00

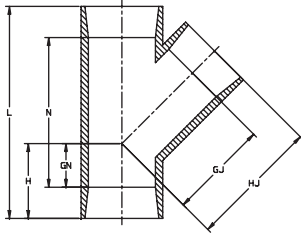

45° Wye (SxSxS)

Size	Part Number	List \$/ea.	Std. Pack	GJ	GN	H	HJ	L	N
10	*9875-100H	2,331.04	1	16.98	5.73	10.73	21.98	33.21	23.21
12	*9875-120H	3,313.92	1	19.39	6.14	12.14	25.39	38.03	26.03

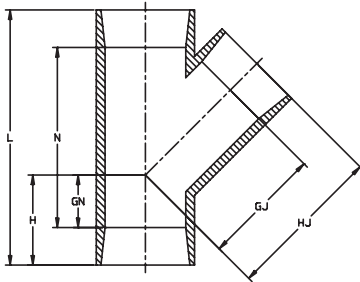

Reducing 45° Wye (SxSxS)

Size	Part Number	List \$/ea.	Std. Pack	GJ	GN	H	HJ	L	N
10 x 2	*9875-619H	818.26	1	12.04	-0.20	4.80	13.04	21.36	11.36
10 x 3	*9875-621H	909.25	1	12.80	0.60	5.60	14.10	22.95	12.95
10 x 4	*9875-623H	1,091.48	1	13.10	1.31	6.31	15.10	24.36	14.36
10 x 6	*9875-626H	1,219.75	1	14.16	2.81	7.81	17.16	27.37	17.37
10 x 8	*9875-628H	1,470.03	1	15.41	4.22	9.22	19.41	30.2	20.2
12 x 2	*9875-659H	1,131.02	1	13.45	-1.20	4.80	14.45	23.36	11.36
12 x 3	*9875-661H	1,201.34	1	14.01	-0.40	5.60	15.51	24.95	12.95
12 x 4	*9875-663H	1,764.64	1	14.51	0.31	6.31	16.51	26.36	14.36
12 x 6	*9875-666H	1,873.16	1	15.58	1.81	7.81	18.58	29.37	17.37
12 x 8	*9875-668H	2,492.60	1	16.83	3.22	9.22	20.83	32.2	20.2
12 x 10	*9875-670H	2,752.98	1	18.39	4.73	10.73	23.39	35.21	23.21

^ = 40% Restock Charge

* = Non-Cancelable / Non-Returnable

Dimensions are subject to change. Please see online "Price Lists" at <http://www.gfppiping.com> for up-to-date information.

Manual Ball Valves

P/L 38 : Type 546 True Union Ball Valve-CPVC



Solvent Cement Socket/Threaded NPT

Size	Part Number/ EPDM Seals	\$ List/ea.	Part Number/ FPM Seals	\$ List/ea.
3/8	163 546 341	67.00	163 546 351	75.00
1/2	163 546 342	68.00	163 546 352	76.00
3/4	163 546 343	76.00	163 546 353	85.00
1	163 546 344	95.00	163 546 354	106.00
1 1/4	163 546 345	126.00	163 546 355	140.00
1 1/2	163 546 346	147.00	163 546 356	164.00
2	163 546 347	187.00	163 546 357	219.00



ANSI Flanged

Size ID Inch	Part Number/ EPDM Seals	\$ List/ea.	Part Number/ FPM Seals	\$ List/ea.
1/2	163 546 582	122.00	163 546 592	75.00
3/4	163 546 583	130.00	163 546 593	76.00
1	163 546 584	164.00	163 546 594	85.00
1 1/4	163 546 585	205.00	163 546 595	106.00
1 1/2	163 546 586	215.00	163 546 596	164.00
2	163 546 587	282.00	163 546 597	219.00

P/L 15 : Type 375 True Union Ball Valve-CPVC



Socket/Threaded NPT

Size	Part Number/ EPDM Seals	\$ List/ea.	Part Number/ FPM Seals	\$ List/ea.
1/2	163 375 002	41.00	163 375 017	51.00
3/4	163 375 003	49.00	163 375 018	62.00
1	163 375 004	57.00	163 375 019	73.00
1 1/4	163 375 005	77.00	163 375 020	104.00
1 1/2	163 375 006	98.00	163 375 021	134.00
2	163 375 007	144.00	163 375 022	180.00
2 1/2 ¹	163 375 008	242.00	163 375 023	283.00
3 ¹	163 375 009	330.00	163 375 024	374.00
4 ¹	163 375 010	562.00	163 375 025	596.00

¹ = 2 1/2" - 6" includes socket only



Flanged

Size	Part Number/ EPDM Seals	\$ List/ea.	Part Number/ FPM Seals	\$ List/ea.
1/2	163 375 062	118.00	163 375 077	126.00
3/4	163 375 063	129.00	163 375 078	141.00
1	163 375 064	140.00	163 375 079	153.00
1 1/4	163 375 065	151.00	163 375 080	172.00
1 1/2	163 375 066	192.00	163 375 081	220.00
2	163 375 067	260.00	163 375 082	310.00
2 1/2	163 375 068	370.00	163 375 083	410.00
3	163 375 069	415.00	163 375 084	450.00
4	163 375 070	610.00	163 375 085	650.00

Manual Butterfly Valves

P/L 74: Type 567 Butterfly Valve-CPVC

Hand Lever with Ratchet Settings

- Connecting dimension: ISO 7005 PN 10, EN 1092 PN 10, DIN 2501 PN 10, ANSI B 16.5 Class 150, BS 1560: 1958, JIS B 2220
- Overall length according to EN 558-1, ISO 5752

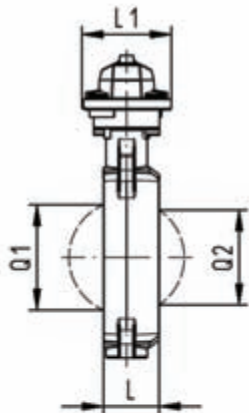
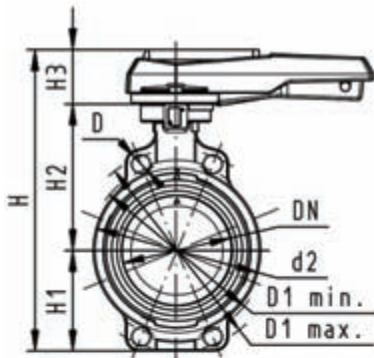
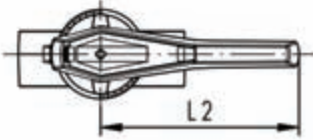

Inch	PSI	Cv	EPDM	List \$/ea.	FPM	List \$/ea.
2	150	103	^163 567 002	320.00	^163 567 062	820.00
2½	150	154	^163 567 003	325.00	^163 567 063	827.00
3	150	210	^163 567 004	358.00	^163 567 064	893.00
4	150	455	^163 567 005	417.00	^163 567 065	963.00
5	150	805	^163 567 006	525.00	^163 567 066	1,200.00
6	150	1162	^163 567 007	561.00	^163 567 067	1,224.00
8	150	2772	^163 567 008	727.00	^163 567 068	1,481.00

Inch	D	D1 min	D1 max	d2	H	H1	H2	H3
2	0.75	4.72	4.92	4.09	10.39	3.03	5.28	2.13
2½	0.75	5.5	5.71	4.53	10.91	3.27	5.51	2.13
3	0.75	5.91	6.3	5.16	11.38	3.5	5.75	2.13
4	0.75	6.89	7.5	6.34	12.8	4.09	6.57	2.17
5	0.91	8.27	8.5	7.36	13.86	4.61	7.13	2.17
6	0.94	9.5	9.5	8.46	14.69	5.12	7.44	2.17
8	0.91	11.42	11.61	10.51	17.13	6.22	8.27	2.64

Inch	L	L1	L2	Q1	Q2
2	1.77	4.17	8.07	1.57	-
2½	1.81	4.17	8.07	2.13	1.38
3	1.93	4.17	8.07	2.64	1.97
4	2.2	4.17	10.04	3.46	2.91
5	2.52	4.17	10.04	4.45	3.82
6	2.83	4.17	10.04	5.47	4.84
8	2.87	5.51	16.06	7.01	6.65

^ = 40% Restock Charge

* = Non-Cancelable / Non-Returnable

Dimensions are subject to change. Please see online "Price Lists" at <http://www.gfpiping.com> for up-to-date information.

Manual Butterfly Valves

P/L 74: Type 567 Butterfly Valve-CPVC

Reduction Gear with Handwheel

- Connecting dimension: ISO 7005 PN 10, EN 1092 PN 10, DIN 2501 PN 10, ANSI B 16.5 Class 150, BS 1560: 1958, JIS B 2220
- Overall length according to EN 558-1, ISO 5752

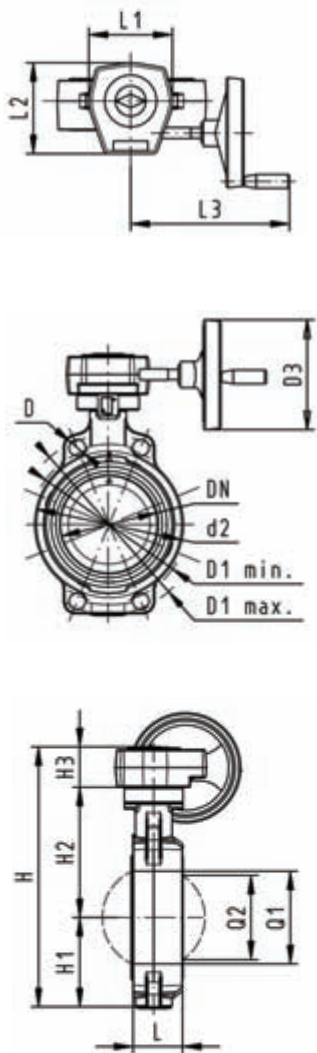

Inch	PSI	Cv	EPDM	List \$/ea.	FPM	List \$/ea.
2	150	103	^162 567 042	550.00	^163 567 062	585.00
2½	150	154	^162 567 043	574.00	^163 567 063	610.00
3	150	210	^162 567 044	610.00	^163 567 064	658.00
4	150	455	^162 567 045	676.00	^163 567 065	718.00
5	150	805	^162 567 046	782.00	^163 567 066	836.00
6	150	1162	^162 567 047	783.00	^163 567 067	885.00
8	150	2772	^162 567 048	927.00	^163 567 068	1,053.00

Inch	D	D1 min.	D1 max.	d2	D3	H	H1
2	0.75	4.72	4.92	4.09	6.3	10.94	3.03
2½	0.75	5.5	5.71	4.53	6.3	11.46	3.27
3	0.75	5.91	6.3	5.16	6.3	11.93	3.5
4	0.75	6.89	7.5	6.34	6.3	13.35	4.09
5	0.91	8.27	8.5	7.36	6.3	14.37	4.61
6	0.94	9.5	9.5	8.46	6.3	15.23	5.12
8	0.91	11.42	11.61	10.51	6.3	17.17	6.22

Inch	H2	H3	L	L1	L2	L3	Q1	Q2
2	5.28	2.68	1.77	4.72	5.2	9.29	1.57	-
2½	5.51	2.68	1.81	4.72	5.2	9.29	2.13	1.38
3	5.75	2.68	1.93	4.72	5.2	9.29	2.64	1.97
4	6.57	2.68	2.2	4.72	5.2	9.29	3.46	2.91
5	7.13	2.68	2.52	4.72	5.2	9.29	4.45	3.82
6	7.44	2.68	2.83	4.72	5.2	9.29	5.47	4.84
8	8.27	2.68	2.87	4.72	5.2	9.29	7.01	6.65

^ = 40% Restock Charge

* = Non-Cancelable / Non-Returnable

Dimensions are subject to change. Please see online "Price Lists" at <http://www.gfpiping.com> for up-to-date information.

George Fischer Piping Systems

CPVC Pressure Piping System Specification Submittal Data Sheet Schedule 80 Pipe and Fittings

Pipe:

Pipe will be manufactured to the dimensions and tolerances of ASTM F441. The CPVC material shall be Type I, Grade IV with a cell classification of 23447-B and conform to ASTM D1784. The pipe will conform to NSF 14 & 61, CSA B137.6 (up to 4"), and UPC® standards

- CPVC Sch.80 Type I, Group I Plain End Pipe - 20 ft. Lengths

Fittings

Socket type molded fittings will be manufactured to the dimensions and tolerances of ASTM F439. Threaded type (NPT) molded fittings will be manufactured to the dimensions and tolerances of ASTM F437 and meet the requirements of ANSI/ASME B 1.20.1. Flanges shall meet the O.D. and bolt hole patterns as specified in ANSI/ASME B 16.5. The CPVC material shall be Type I, Grade IV with a cell classification of 23447-B and conform to ASTM D1784. The fittings will conform to NSF 14 & 61, and UPC® standards.

- CPVC Sch.80 Type I, Grade I Socket Type
- CPVC Sch.80 Type I, Grade I Threaded Type
- CPVC Sch.80 Type I, Grade I Flange Type

Job Name: _____

Job Location: _____

Engineer: _____

Contractor: _____

Representative: _____



GEORG FISCHER
PIPING SYSTEMS