

BROUGHT TO YOU BY BAR MANUFACTURING, LLC

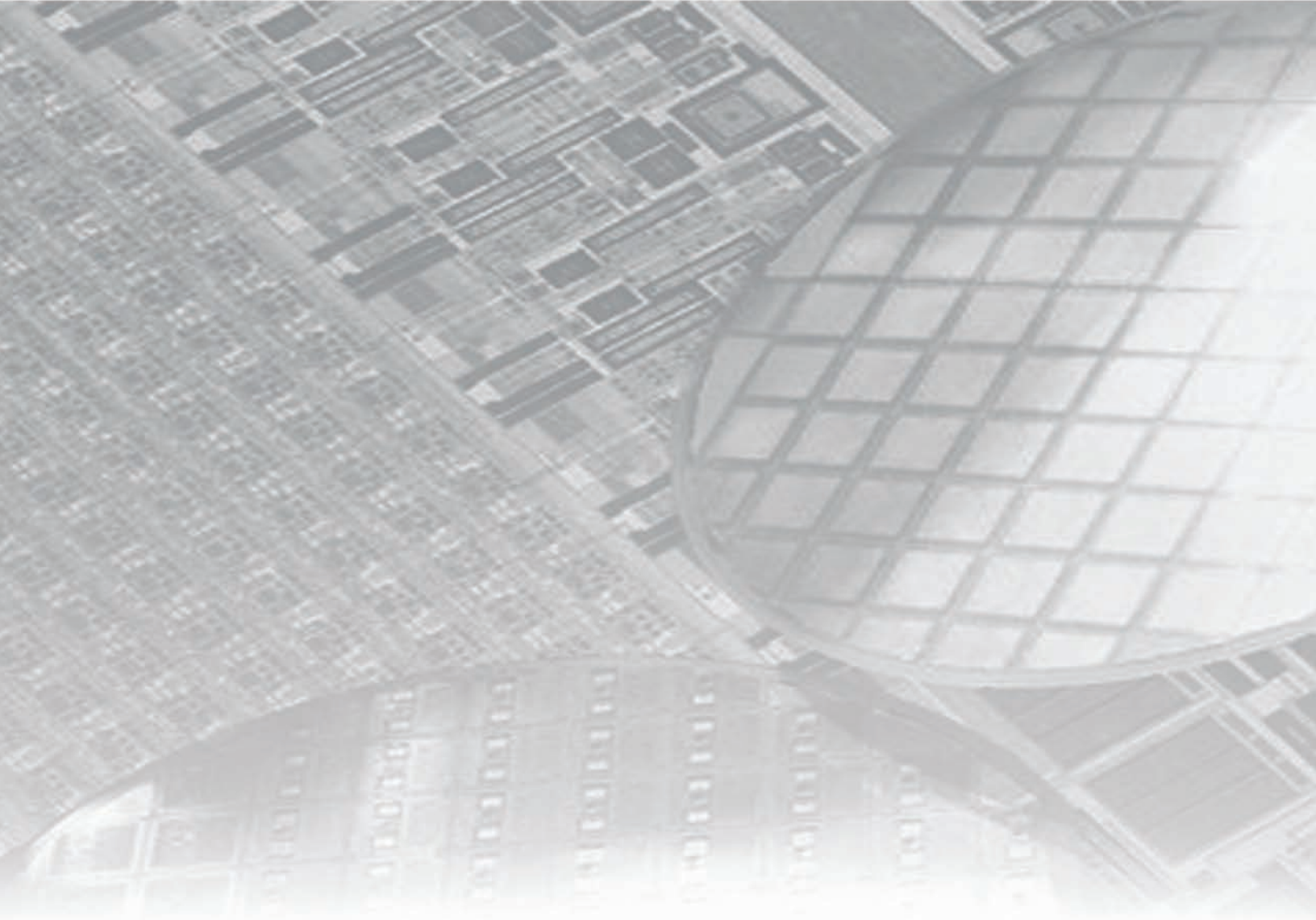

ULTRA HIGH PURITY GAS DELIVERY COMPONENTS



**BAR MANUFACTURING, LLC
A SUBSIDIARY OF COMPART ENGINEERING, INC.**

www.barmfg.us

DISTRIBUTOR OR ACCOUNT SALES REPRESENTATIVE:

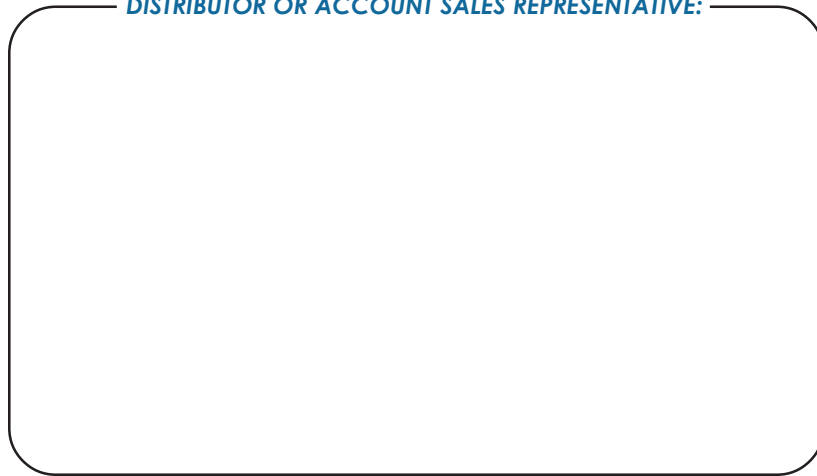

Standard Products:

Please note this catalog contains our standard UHP product line. Please contact your distributor or sales representative for a current price list.

Non-Standard Products:

BAR Manufacturing also offers a variety of non-standard components not featured in this catalog. Please contact your distributor or sales representative for further details.

Build-to-Print Products:

For UHP Custom Machining products please contact our Corporate Headquarters/Sales Department at 916-939-0551.



CONTENTS

Product Information

Glands _____	2-4
Elbows / Tribows / Crosses _____	5-6
Tees _____	7
Nuts / Caps / Plugs _____	8
Bodies _____	9-12
Reducing Unions _____	13
High Flow Connections _____	14-15
Gaskets _____	16
Welded Assemblies _____	17

Other

BAR UHP Process & Material Specification _____	18-20
Company Information _____	21

HELPFUL INFORMATION

Materials for Standard Components	Applicable Specification
1 = 316 SS	BAR Stock: ASME SA479, ASTM A276 Forge Parts: ASME SA182, ASTM A31
2 = 316L SS	BAR Stock: ASME SA479, ASTM A276 Forge Parts: ASME SA182, ASTM A31
3 = 316L VAR (Vacuum Arc Remelt)	BAR Stock: ASME SA479, ASTM A276 Forge Parts: ASME SA182
Gaskets	Applicable Specification
Ni = Nickel	ASTM B162
SS = Stainless Steel	ASTM A240, ASTM A167
EP - Electropolished per SEMI F19 NEP - Passivated per ASTM A967 (Non-Electropolished)	Sizing - 2=1/8" 4=1/4" 6=3/8" 8=1/2" 12=3/4" 16=1"
Pressure Ratings - Ratings are based upon tests conducted using BAR Assemblies. All ratings comply with calculations per ANSI Code for Pressure Piping B31.3. Working pressure ratings are determined at room temperature.	Ultra High Purity - A variety of BAR's factory seal glands are controlled surface and electropolished finishes. They have been cleaned to meet ultra high purity standards.
Heat Code Traceability for all Glands and Components - Material Heat Codes are stamped on all glands and shapes to ensure raw material traceability. Copies of product heat codes are available to download from our website: www.barmfg.us (downloads)	Plating - All female nuts are silver plated. Customers must be careful to avoid chemical processes, passivation, and electropolishing when cleaning nuts. If plating is damaged or removed, galling or damage to the components and thread area may occur.

GLANDS

SHORT TUBE BUTT WELD

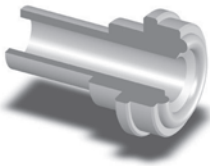
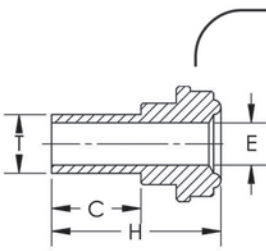

T Tube OD	Ordering Number	C		E		H		VC Size	Nominal Wall Thickness	Working Pressure	
		in.	mm	in.	mm	in.	mm			psig	bar
<i>fractional</i>											
1/8	3-EP-2-VC-3S-2TB7	0.75	19.1	0.06	1.5	1.08	27.4	1/8	0.028	8500	580
1/4	3-EP-4-VC-3S-4TB2-520	0.25	6.4	0.18	4.6	.520	13.20	1/4	0.035	5100	350
1/4	3-EP-4-VC-3S-4TB2-555	0.25	6.4	0.18	4.6	.555	14.09	1/4	0.035	5100	350
1/4	3-EP-4-VC-3S-4TB2	0.25	6.4	0.18	4.6	0.60	15.2	1/4	0.035	5100	350
1/4	2-NEP-4-VC-3S-4TB2	0.25	6.4	0.18	4.6	0.60	15.2	1/4	0.035	5100	350
1/4	3-EP-4-VC-3S-4TB3	0.38	9.6	0.18	4.6	0.72	18.3	1/4	0.035	5100	350
1/4	3-EP-4-VC-3S-4TB7	0.75	19.1	0.18	4.6	1.10	27.9	1/4	0.035	5100	350
1/4	3-EP-8-VC-3S-4TB7	0.75	19.1	0.18	4.6	1.12	28.4	1/2	0.035	4300	290
3/8	3-EP-8-VC-3S-6TB2	0.25	6.4	0.31	7.9	0.62	15.7	1/2	0.035	3300	220
3/8	3-EP-8-VC-3S-6TB7	0.75	19.1	0.31	7.9	1.12	28.4	1/2	0.035	3300	220
3/8	2-NEP-8-VC-3S-6TB7	0.75	19.1	0.31	7.9	1.12	28.4	1/2	0.035	3300	220
1/2	3-EP-8-VC-3S-8TB2	0.25	6.4	0.40	10.2	0.62	15.7	1/2	0.049	3500	240
1/2	3-EP-8-VC-3S-8TB3	0.38	9.6	0.40	10.2	0.74	18.8	1/2	0.049	3500	240
1/2	3-EP-8-VC-3S-8TB7	0.75	19.1	0.40	10.2	1.12	28.4	1/2	0.049	3500	240
1/2	2-NEP-8-VC-3S-8TB7	0.75	19.1	0.40	10.2	1.12	28.4	1/2	0.049	3500	240
3/4	3-EP-12-VC-3S-12TB7	0.75	16.5	0.65	16.5	1.38	35.1	3/4	0.049	2400	165
<i>metric</i>											
6mm	3-EP-4-VC-3S-6MTB7	0.75	19.1	0.16	4.0	1.16	29.5	1/4	1.0mm	6800	460
8mm	3-EP-4-VC-3S-8MTB7	0.75	19.1	0.24	6.0	1.16	29.5	1/4	1.0mm	4900	330
10mm	3-EP-8-VC-3S-10MTB7	0.75	19.1	0.31	8.0	1.16	29.5	1/2	1.0mm	3500	240
12mm	3-EP-8-VC-3S-12MTB7	0.75	19.1	0.39	10.0	1.16	29.5	1/2	1.0mm	3100	210
18mm	3-EP-12-VC-3S-18MTB7	0.75	19.1	0.59	15.0	1.22	31.0	3/4	1.5mm	3000	200

LONG TUBE BUTT WELD

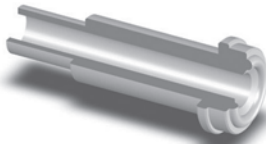
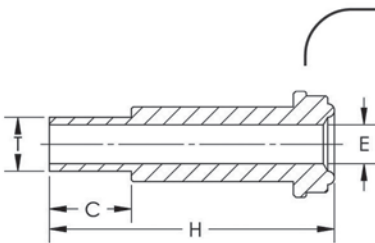

T Tube OD	Ordering Number	C		E		H		VC Size	Nominal Wall Thickness	Working Pressure	
		in.	mm	in.	mm	in.	mm			psig	bar
<i>fractional</i>											
1/8	3-EP-2-VC-3-2TB7	0.75	19.1	0.06	1.5	1.42	36.1	1/8	0.028	8500	580
1/4	3-EP-4-VC-3-4TB2	0.25	6.4	0.18	4.6	1.20	30.5	1/4	0.035	5100	350
1/4	3-EP-4-VC-3-02205	0.36	9.1	0.18	4.6	1.31	33.3	1/4	0.035	5100	350
1/4	3-EP-4-VC-3-4TB3	0.38	9.6	0.18	4.6	1.32	33.5	1/4	0.035	5100	350
1/4	3-EP-4-VC-3-4TB7	0.75	19.1	0.18	4.6	1.70	43.2	1/4	0.035	5100	350
1/4	3-NEP-4-VC-3-4TB7	0.75	19.1	0.18	4.6	1.70	43.2	1/4	0.035	5100	350
1/4	3-EP-8-VC-3-4TB7	0.75	19.1	0.18	4.6	1.80	45.7	1/2	0.035	3500	240
3/8	3-EP-8-VC-3-6TB2	0.25	6.4	0.31	7.9	1.29	32.8	1/2	0.035	3300	220
3/8	3-EP-8-VC-3-6TB7	0.75	19.1	0.31	7.9	1.79	45.5	1/2	0.035	3300	220
1/2	3-EP-8-VC-3-8TB2	0.25	6.4	0.40	10.2	1.29	32.8	1/2	0.049	3500	240
1/2	3-EP-8-VC-3-8TB3	0.38	9.6	0.40	10.2	1.41	35.8	1/2	0.049	3500	240
1/2	3-EP-8-VC-3-8TB7	0.75	19.1	0.40	10.2	1.79	45.5	1/2	0.049	3500	240
1/2	2-NEP-8-VC-3-8TB7	0.75	19.1	0.40	10.2	1.79	45.5	1/2	0.049	3500	240
3/4	3-EP-12-VC-3-12TB7	0.75	19.1	0.65	16.5	2.03	51.6	3/4	0.049	2400	165
<i>metric</i>											
6mm	3-EP-4-VC-3-6MTB7	0.75	19.1	0.16	4.0	1.70	43.2	1/4	1.0mm	6800	460
8mm	3-EP-4-VC-3-8MTB7	0.75	19.1	0.24	6.0	1.70	43.2	1/4	1.0mm	4900	330
10mm	3-EP-8-VC-3-10MTB7	0.75	19.1	0.31	8.0	1.79	45.5	1/2	1.0mm	3500	240
12mm	3-EP-8-VC-3-12MTB7	0.75	19.1	0.39	10.0	1.79	45.5	1/2	1.0mm	3100	210
18mm	3-EP-12-VC-3-18MTB7	0.75	19.1	0.59	15.0	2.03	51.6	3/4	1.5mm	3000	200

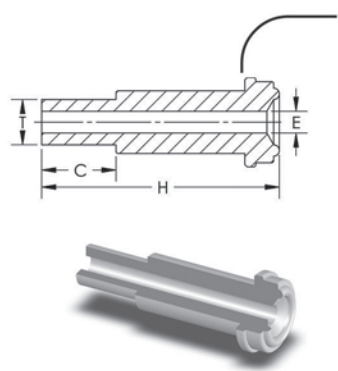

MALE WELD

T Tube OD	Ordering Number	C		E		H		VC Size	Working Pressure	
		in.	mm	in.	mm	in.	mm		psig	bar
<i>fractional</i>										
1/8	2-NEP-2-VC-3-2MTW	0.28	7.1	0.06	1.5	0.70	17.8	1/8	9000	620
1/8	2-NEP-4-VC-3-2MTW	0.28	7.1	0.06	1.5	1.31	33.3	1/4	8000	550
1/4	2-NEP-4-VC-3-4MTW	0.41	10.4	0.12	3.0	1.31	33.3	1/4	8000	550
1/4	2-NEP-8-VC-3-4MTW	0.41	10.4	0.12	3.0	1.50	38.1	1/2	3500	240
3/8	2-NEP-8-VC-3-6MTW	0.41	10.4	0.28	7.1	1.50	38.1	1/2	3500	240
1/2	2-NEP-8-VC-3-8MTW	0.50	12.7	0.40	10.2	1.50	38.1	1/2	3500	240

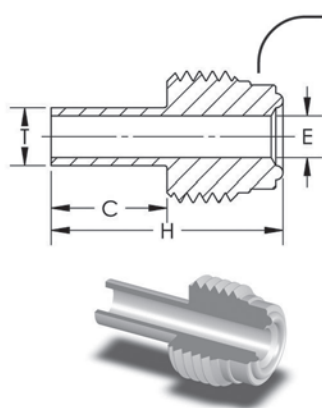

FIXED MALE

T Tube OD	Ordering Number	C		E		H		VC Size	Working Pressure	
		in.	mm	in.	mm	in.	mm		psig	bar
<i>fractional</i>										
1/4	3-EP-4-VC-3T-4	0.50	12.7	0.18	4.6	1.00	25.4	1/4	5100	350
1 1/32	3-EP-4-VC-3T-5.5			0.25	6.4				3300	220
3/8	3-EP-4-VC-3T-6			0.25	6.4				3300	220

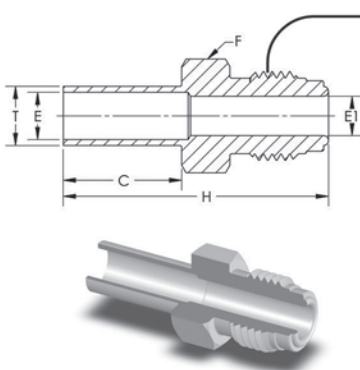

FIXED MALE WITH HEX

T Tube OD	Ordering Number	C		E		H		E1		F HEX SIZE	VC Size	Working Pressure	
		in.	mm	in.	mm	in.	mm	in.	mm			psig	bar
<i>fractional</i>													
1/4	3-EP-4-VC-3HT-4	0.75	19.1	0.18	4.6	1.68	42.7	0.18	4.6	5/8	1/4	5100	350
1 1/32	3-EP-4-VC-3HT-5.5			0.25	6.4			0.25	6.4			3300	220
3/8	3-EP-4-VC-3HT-6			0.30	7.6			0.25	6.4			3300	220

GLANDS

SHORT SOCKET WELD

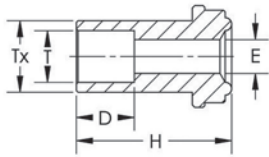

T Tube Socket	Ordering Number	D		E		H		Tx		VC Size	Working Pressure	
		in.	mm	in.	mm	in.	mm	in.	mm		psig	bar
fractional												
1/4	2-NEP-4-VC-3-.50LG	0.28	7.1	0.18	4.6	0.50	12.7	0.35	8.9	1/4	5500	370
1/4	2-NEP-4-VC-3-.75LG	0.28	7.1	0.18	4.6	0.75	19.1	0.35	8.9	1/4	5500	370

SOCKET WELD

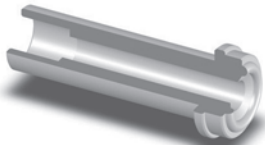
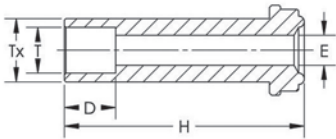

T Tube Socket	Ordering Number	D		E		H		Tx		VC Size	Working Pressure	
		in.	mm	in.	mm	in.	mm	in.	mm		psig	bar
fractional												
1/8	2-NEP-2-VC-3	0.10	2.5	0.09	2.3	0.70	17.8	0.20	5.1	1/8	7100	480
1/4	2-NEP-4-VC-3	0.28	7.1	0.18	4.6	1.31	33.3	0.35	8.9	1/4	5500	370
3/8	2-NEP-6-VC-3	0.31	7.9	0.28	7.1	1.50	38.1	0.60	15.2	1/2	3500	240
1/2	2-NEP-8-VC-3	0.38	9.6	0.40	10.2	1.50	38.1	0.60	15.2	1/2	3000	200

REDUCING SOCKET WELD

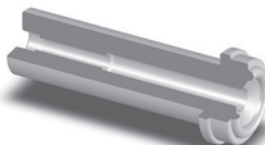
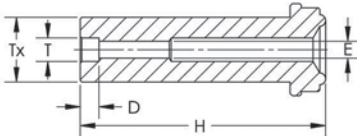

T Tube Socket	Ordering Number	D		E		H		Tx		VC Size	Working Pressure	
		in.	mm	in.	mm	in.	mm	in.	mm		psig	bar
fractional												
1/8	2-NEP-4-VC-3-2TSW	0.10	2.5	0.09	2.3	1.31	33.3	0.35	8.9	1/4	8000	550
1/4	2-NEP-8-VC-3-4TSW	0.28	7.1	0.18	4.6	1.50	38.1	0.60	15.2	1/2	3500	240

BLIND (UNDRILLED) GLAND

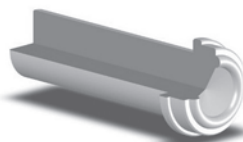
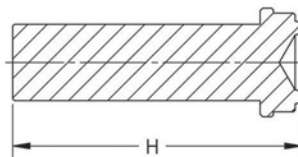

T Tube Socket	Ordering Number	H		VC Size
		in.	mm	
fractional				
1/8	1-2-VC-3-BL	0.70	17.8	1/8
1/4	1-4-VC-3-BL	1.31	33.3	1/4
1/2	1-8-VC-3-BL	1.50	38.1	1/2

Material Type: 316L, Passivated per ASTM A 967.

90 DEGREE UNION ELBOWS

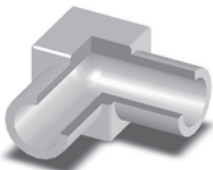
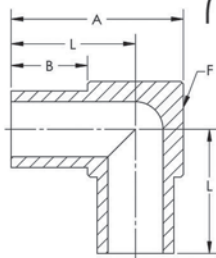

Tube OD	Wall Thickness	Ordering Number	Dimensions				Pressure Rating
			A	B	F Flat	L	
<i>Dimensions, in. (mm)</i>							<i>psig (bar)</i>
1/8	0.028	3-EP-2MW-9	0.56 (14.2)	0.25 (6.4)	5/16	0.41 (10.4)	8500 (585)
1/4	0.035	3-EP-4MW-9	0.69 (17.5)			7/16	0.47 (11.9)
3/8		3-EP-6MW-9			9/16	0.53 (13.5)	3700 (227)
1/2	0.049	3-EP-8MW-9	0.81 (20.6)				3700 (254)
<i>Dimensions, mm (in.)</i>							<i>bar (psig)</i>
6	1	3-EP-6MMW-9	14.2 (0.56)	6.4 (0.25)	(5/16)	10.4 (0.41)	420 (6095)
8		3-EP-8MMW-9	17.5 (0.69)		(7/16)	11.9 (0.47)	310 (4499)
10		3-EP-10MMW-9			(9/16)	13.5 (0.53)	240 (3483)
12		3-EP-12MMW-9	20.6 (0.81)				200 (2902)

REDUCING 90 DEGREE ELBOWS

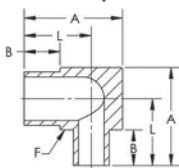

Tube OD	Wall Thickness	Tube OD	Wall Thickness	Ordering Number	Dimensions				Pressure Rating
					A	B	F Flat	L	
<i>Dimensions, in. (mm)</i>									<i>psig (bar)</i>
3/8	0.035	1/4	0.035	3-EP-6MW-9-4	0.69 (17.5)	0.25 (6.4)	7/16	0.47 (11.9)	3300 (227)
1/2	0.049	1/4		3-EP-8MW-9-4	0.81 (20.6)		9/16	0.53 (13.5)	3700 (254)
1/2		3/8		3-EP-8MW-9-6				3300 (227)	
<i>Dimensions, mm (in.)</i>									<i>bar (psig)</i>
8	1	6	1	3-EP-8MMW-9-6M	17.5 (0.69)	6.4 (0.25)	(7/16)	11.9 (0.47)	310 (4499)
10		6		3-EP-10MMW-9-6M					240 (3483)
12		6		3-EP-12MMW-9-6M	20.6 (0.81)		(9/16)	13.5 (0.53)	200 (2902)
12		8		3-EP-12MMW-9-8M					

EXTENDED LEG 90 DEGREE ELBOWS

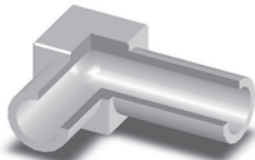
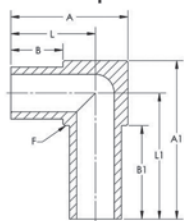

Tube OD	Wall Thickness	Ordering Number	Dimensions							Pressure Rating
			A	A _i	B	B _i	F Flat	L	L ₁	
<i>Dimensions, in. (mm)</i>										<i>psig (bar)</i>
1/4	0.035	3-EP-4MW-9-03442	0.56 (14.2)	0.76 (19.3)	0.25 (6.4)	0.45 (11.4)	5/16	0.41 (10.4)	0.61 (15.5)	5100 (351)
		3-EP-4MW-9-03443		0.81 (20.6)		0.50 (12.7)			0.66 (16.8)	
		3-EP-4MW-9-03444	0.76 (19.3)	0.76 (19.3)	0.45 (11.4)	0.45 (11.4)		0.61 (15.5)	0.61 (15.5)	
		3-EP-4MW-9-03445	0.81 (20.6)	0.81 (20.6)	0.50 (12.7)	0.50 (12.7)		0.66 (16.8)	0.66 (16.8)	

ELBOWS / TRIBOWS / CROSSES

45 DEGREE UNION ELBOWS

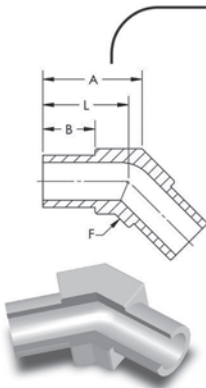

Tube OD	Wall Thickness	Ordering Number	Dimensions				Pressure Rating
			A	B	F Flat	L	
			<i>Dimensions, in. (mm)</i>				<i>psig (bar)</i>
1/4	0.035	3-EP-4MW-5	0.47 (11.9)	0.25 (6.4)	5/16	0.41 (10.4)	5100 (351)
3/8		3-EP-6MW-5	0.56 (14.2)		7/16	0.47 (11.9)	3300 (227)
1/2	0.049	3-EP-8MW-5	0.64 (16.2)		9/16	0.53 (13.5)	3700 (254)

TRIBOWS

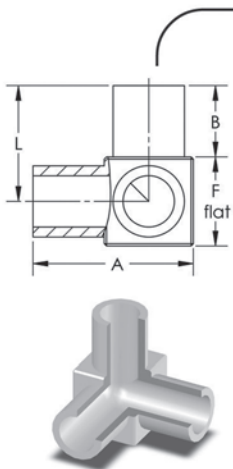

Tube OD	Wall Thickness	Ordering Number	Dimensions				Pressure Rating
			A	B	F Flat	L	
			<i>Dimensions, in. (mm)</i>				<i>psig (bar)</i>
1/4	0.035	3-EP-4MW-91	0.56 (14.2)	0.25 (6.4)	5/16	0.41 (10.4)	5100 (351)
3/8		3-EP-6MW-91	0.69 (17.5)		7/16	0.47 (11.9)	3300 (227)
1/2	0.049	3-EP-8MW-91	0.81 (20.6)		9/16	0.53 (13.5)	3700 (254)
			<i>Dimensions, mm (in.)</i>				<i>bar (psig)</i>
6	1	3-EP-6MMW-91	14.2 (0.56)	6.4 (0.25)	(5/16)	10.4 (0.41)	420 (6095)

UNION CROSSES

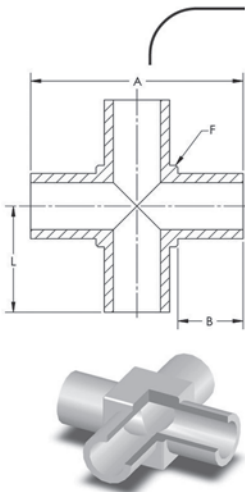

Tube OD	Wall Thickness	Ordering Number	Dimensions				Pressure Rating
			A	B	F Flat	L	
			<i>Dimensions, in. (mm)</i>				<i>psig (bar)</i>
1/8	0.028	3-EP-2MW-4	0.82 (20.8)	0.25 (6.4)	5/16	0.41 (10.4)	8500 (585)
1/4	0.035	3-EP-4MW-4					5100 (351)
3/8		3-EP-6MW-4	0.94 (23.9)		7/16	0.47 (11.9)	3300 (227)
1/2	0.049	3-EP-8MW-4	1.06 (26.9)		9/16	0.53 (13.5)	3700 (254)
			<i>Dimensions, mm (in.)</i>				<i>bar (psig)</i>
6	1	3-EP-6MMW-4	20.6 (0.81)	6.4 (0.25)	(5/16)	10.4 (0.41)	420 (6095)
8		3-EP-8MMW-4	23.9 (0.94)		(7/16)	11.9 (0.47)	310 (4499)
10		3-EP-10MMW-4					240 (3483)
12		3-EP-12MMW-4	26.9 (1.06)		(9/16)	13.5 (0.53)	200 (2902)

UNION TEES

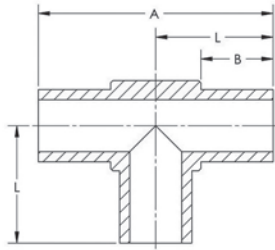

Tube OD	Wall Thickness	Ordering Number	Dimensions				Pressure Rating
			A	B	F Flat	L	
			<i>Dimensions, in. (mm)</i>				<i>psig (bar)</i>
1/8	0.028	3-EP-2MW-3	0.82 (20.8)	0.25 (6.4)	5/16	0.41 (10.4)	8500 (585)
1/4	0.035	3-EP-4MW-3	0.94 (23.9)			0.47 (11.9)	5100 (351)
		3-NEP-4MW-3			7/16	0.53 (13.5)	3300 (227)
3/8	0.049	3-EP-6MW-3	1.06 (26.9)			9/16	0.53 (13.5)
1/2	0.049	3-EP-8MW-3	1.06 (26.9)	9/16	0.53 (13.5)	3700 (254)	
			<i>Dimensions, mm (in.)</i>				<i>bar (psig)</i>
6	1	3-EP-6MMW-3	20.8 (0.82)	6.4 (0.25)	(5/16)	10.4 (0.41)	420 (6095)
8		3-EP-8MMW-3	23.9 (0.94)		(7/16)	11.9 (0.47)	310 (4499)
10		3-EP-10MMW-3	26.9 (1.06)		(9/16)	13.5 (0.53)	240 (3483)
12		3-EP-12MMW-3	26.9 (1.06)		(9/16)	13.5 (0.53)	200 (2902)

EXTENDED BRANCH LEG UNION TEES

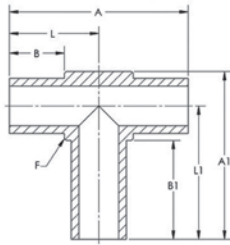

Tube OD	Wall Thickness	Ordering Number	Dimensions						Pressure Rating	
			A	A ₁	B	B ₁	F Flat	L		L ₁
			<i>Dimensions, in. (mm)</i>						<i>psig (bar)</i>	
1/4	0.035	3-EP-4MW-3-03446	0.82 (20.8)	0.76 (19.3)	0.25 (6.4)	0.45 (11.4)	5/16	0.41 (10.4)	0.61 (15.5)	5100 (351)

REDUCING TEES

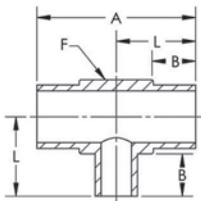

Tube OD	Wall Thickness	Tube OD	Wall Thickness	Ordering Number	Dimensions				Pressure Rating
					A	B	F Flat	L	
					<i>Dimensions, in. (mm)</i>				<i>psig (bar)</i>
3/8	0.035	1/4	0.035	3-EP-6MW-3-6-4	0.94 (23.9)	0.25 (6.4)	7/16	0.47 (11.9)	3300 (227)
1/2	0.049	1/4		3-EP-8MW-3-8-4	1.06 (26.9)			9/16	0.53 (13.5)
1/2	0.049	3/8		3-EP-8MW-3-8-6		0.53 (13.5)	3300 (227)		
					<i>Dimensions, mm (in.)</i>				<i>bar (psig)</i>
8	1	6	1	3-EP-8MMW-3-8M-6M	23.9 (0.94)	6.4 (0.25)	(7/16)	11.9 (0.47)	310 (4499)
10		6		3-EP-10MMW-3-10M-6M	26.9 (1.06)				(9/16)
12		6		3-EP-12MMW-3-12M-6M			26.9 (1.06)	(9/16)	
12		8		3-EP-12MMW-3-12M-8M	26.9 (1.06)				(9/16)

NUTS / CAPS / PLUGS

FEMALE NUTS

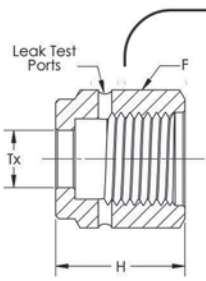

Ordering Number	F Hex Size	H		Tx	
		in.	mm	in.	mm
1-2-VC-1	7/16	0.53	13.5	0.21	5.3
1-4-VC-1	3/4	0.81	20.6	0.36	9.1
1-8-VC-1	1 1/16	0.88	22.4	0.61	15.5
1-12-VC-1	1 1/2	1.12	28.4	0.89	22.6
1-16-VC-1	1 3/4	1.34	34.0	1.20	30.5

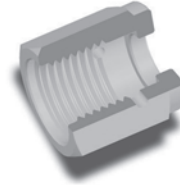

MALE NUTS

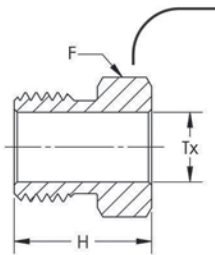

Ordering Number	F Hex Size	H		Tx	
		in.	mm	in.	mm
1-2-VC-4	3/8	0.50	12.7	0.21	5.3
1-4-VC-4	5/8	0.71	18.0	0.36	9.1
1-8-VC-875	7/8	0.81	20.6	0.61	15.5
1-8-VC-4	15/16	0.81	20.6	0.61	15.5
1-12-VC-4	1 5/16	1.00	25.4	0.89	22.6
1-16-VC-4	1 5/8	1.19	30.2	1.20	30.5

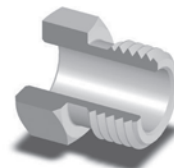

SHORT MALE NUTS

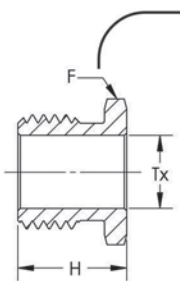

Ordering Number	F Hex Size	H		Tx	
		in.	mm	in.	mm
1-4-VC-4-54NC	5/8	0.54	13.7	0.36	9.1
1-4-VC-4-65NC	5/8	0.65	16.5	0.36	9.1

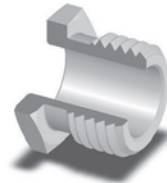

CAPS

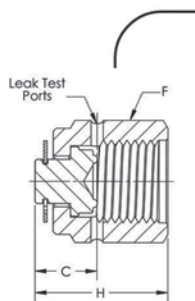

Ordering Number	C		F Hex Size	H	
	in.	mm		in.	mm
1-4-VC-CP	0.44	11.2	3/4	0.94	23.9
1-8-VC-CP	0.45	11.4	1 1/16	1.01	25.6
1-12-VC-CP	0.54	13.7	1 1/2	1.29	32.8
1-16-VC-CP	0.63	16.0	1 3/4	1.54	39.1

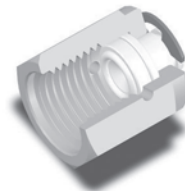

PLUGS

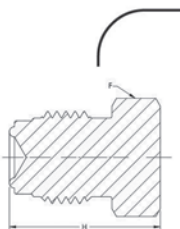

Ordering Number	F Hex Size	H	
		in.	mm
1-2-VC-P	3/8	0.68	17.3
1-4-VC-P	5/8	0.92	23.4
1-8-VC-P-875	7/8	1.08	27.4
1-8-VC-P	15/16	1.08	27.4
1-12-VC-P	1 5/16	1.43	36.3
1-16-VC-P	1 5/8	1.52	38.6

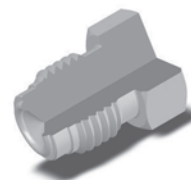

COUPLINGS

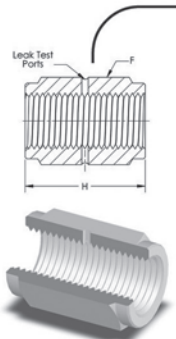

Ordering Number	F Hex Size	H	
		in.	mm
1-2-VC-CG	7/16	0.66	16.8
1-4-VC-CG	3/4	1.19	30.2
1-8-VC-CG	1 1/16	1.31	33.3
1-12-VC-CG	1 1/2	1.68	42.7
1-16-VC-CG	1 3/4	2.04	51.8

DOUBLE MALE UNIONS

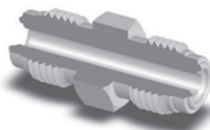
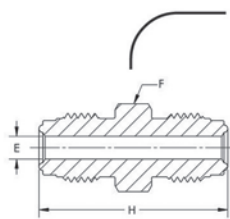

Ordering Number	E		F Hex Size	H		VC Size	Working Pressure	
	in.	mm		in.	mm		psig	bar
	1-2-VC-6-DM	0.09		2.3	3/8		1.13	28.7
1-4-VC-6-DM	0.18	4.6	5/8	1.55	39.4	1/4	8000	550
1-8-VC-6-DM	0.40	10.2	1 5/16	1.84	46.7	1/2	3500	240

DOUBLE MALE REDUCING UNIONS

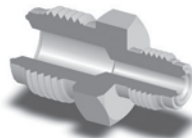
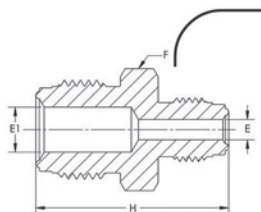

Ordering Number	E		E1		F Hex Size	H		VC Size 1	VC Size 2	Working Pressure	
	in.	mm	in.	mm		in.	mm			psig	bar
	1-4-VC-6-DM-2	0.09	2.3	0.18		4.6	5/8			1.37	34.8
1-8-VC-6-DM-4	0.18	4.6	0.40	10.2	1 5/16	1.71	43.4	1/2	1/4	3500	240

MALE NPT CONNECTORS

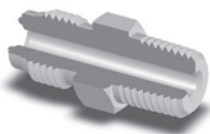
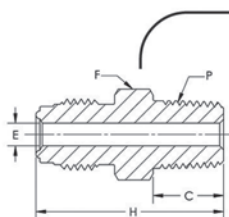

P Male NPT Size	Ordering Number	C		E		F Hex Size	H		VC Size	Working Pressure	
		in.	mm	in.	mm		in.	mm		psig	bar
		<i>fractional</i>									
1/8	1-2-VC-1-2	0.38	9.6	0.09	2.3	7/16	1.07	27.2	1/8	9000	620
1/8	1-4-VC-1-2	0.38	9.6	0.18	4.6	5/8	1.31	33.3	1/4	8000	550
1/4	1-4-VC-1-4	0.56	14.2	0.18	4.6	5/8	1.49	37.8	1/4	8000	550
3/8	1-8-VC-1-6	0.56	14.2	0.38	9.6	1 5/16	1.65	41.9	1/2	3500	240
1/2	1-8-VC-1-8	0.75	19.1	0.40	10.2	1 5/16	1.84	46.7	1/2	3500	240

BODIES

VCR TO MALE NPT ELBOWS

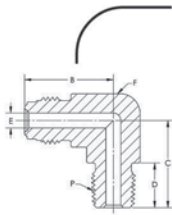

P Male NPT Size	Ordering Number	B		C		D		E		VC Size	F Wrench Size	Working Pressure	
		in.	mm	in.	mm	in.	mm	in.	mm			psig	bar
<i>fractional</i>													
1/8	1-4-VC-2-2	1.07	27.2	0.87	22.1	0.38	9.6	0.18	4.6	1/4	9/16	8000	550
1/4	1-4-VC-2-4	1.07	27.2	1.05	26.7	0.56	14.2	0.18	4.6	1/4	9/16	8000	550
3/8	1-8-VC-2-6	1.45	36.8	1.26	32.0	0.56	14.2	0.40	10.2	1/2	13/16	3500	240
1/2	1-8-VC-2-8	1.45	36.8	1.45	36.8	0.75	19.1	0.40	10.2	1/2	13/16	3500	240



UNION ELBOWS

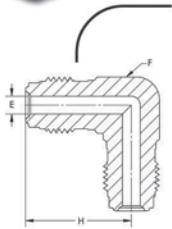

Ordering Number	H		E		VC Size	F Wrench Size	Working Pressure	
	in.	mm	in.	mm			psig	bar
1-2-VC-9	0.89	22.6	0.09	2.3	1/8	7/16	9000	620
1-4-VC-9	1.07	27.2	0.18	4.6	1/4	9/16	8000	550
1-8-VC-9	1.45	36.8	0.40	10.2	1/2	13/16	3500	240



UNION TEES

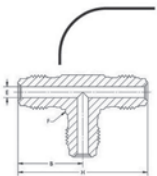

Ordering Number	B		E		H		VC Size	F Wrench Size	Working Pressure	
	in.	mm	in.	mm	in.	mm			psig	bar
1-2-VC-T	0.89	22.6	0.09	2.3	1.78	45.2	1/8	7/16	9000	620
1-4-VC-T	1.07	27.2	0.18	4.6	2.14	54.4	1/4	9/16	8000	550
1-8-VC-T	1.45	36.8	0.40	10.2	2.90	73.7	1/2	13/16	3500	240



UNION CROSSES

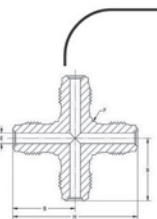

Ordering Number	B		E		H		VC Size	F Wrench Size	Working Pressure	
	in.	mm	in.	mm	in.	mm			psig	bar
1-2-VC-CS	0.89	22.6	0.09	2.3	1.78	45.2	1/8	7/16	9000	620
1-4-VC-CS	1.07	27.2	0.18	4.6	2.14	54.4	1/4	9/16	8000	550
1-8-VC-CS	1.45	36.8	0.40	10.2	2.90	73.7	1/2	13/16	3500	240



FEMALE NPT CONNECTORS

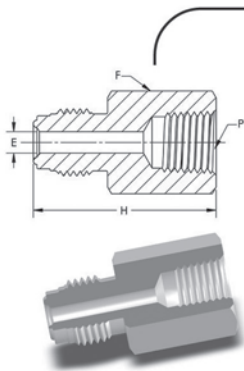

P Female NPT Size	VC Size	Ordering Number	E		F Hex Size	H		Working Pressure	
			in.	mm		in.	mm	psig	bar
<i>fractional</i>									
1/8	1/8	1-2-VC-7-2	0.09	2.3	9/16	1.19	30.2	6500	440
1/8	1/4	1-4-VC-7-2	0.18	4.6	5/8	1.41	35.8	8000	550
1/4	1/4	1-4-VC-7-4	0.18	4.6	3/4	1.54	39.1	6600	450
3/8	1/2	1-8-VC-7-6	0.40	10.2	15/16	1.76	44.7	3500	240
1/2	1/2	1-8-VC-7-8	0.40	10.2	1 1/16	1.99	50.5	3500	240

STRAIGHT THREAD O-RING SEAL MALE CONNECTORS

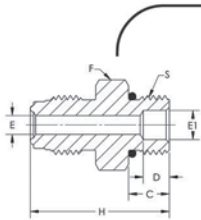

S Straight Thread Size	Ordering Number	C		D		E		E1		F Hex Size	H		Uniform O-ring Size	VC Size	Working Pressure	
		in.	mm	in.	mm	in.	mm	in.	mm		in.	mm			psig	bar
<i>fractional</i>																
9/16-18	1-4-VC-1-00032	0.39	9.9	0.25	6.4	0.18	4.6	0.28	7.1	3/4	1.33	33.8	fluorocarbon 906	1/4	4500	310
7/8-14	1-8-VC-1-00176	0.50	12.7	0.40	10.2	0.28	7.1	0.59	15.0	1	1.66	42.2	fluorocarbon 910	1/2	3500	240
9/16-18	1-8-VC-1-01081	0.39	9.9	N/a	N/a	0.28	7.1	0.28	7.1	15/16	1.48	37.6	fluorocarbon 906	1/2	3500	240

This part can be ordered without O-Ring by placing -A at the end of the part number. Example: 1-4-VC-1-00032-A

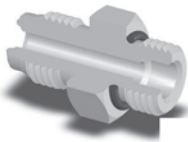

BULKHEAD UNIONS

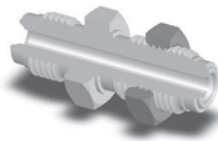
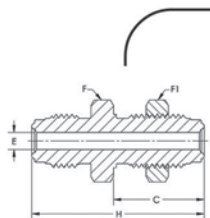

Ordering Number	C		E		F Hex Size	F1 Hex Size	H		Panel Hole Size	Max. Panel Thick- ness	VC Size	Working Pressure	
	in.	mm	in.	mm			in.	mm				psig	bar
1-4-VC-61	1.30	33.0	0.18	4.6	3/4	3/4	2.23	56.6	19/32	0.44	1/4	8000	550
1-4-VC-61S	0.99	25.1	0.18	4.6	3/4	3/4	1.82	46.2	19/32	0.13	1/4	8000	550
1-8-VC-61	1.48	37.6	0.40	10.2	1 1/16	1 1/16	2.57	65.3	29/32	0.50	1/2	3500	240
1-8-VC-61S	1.11	28.2	0.40	10.2	1 1/16	1 1/16	2.14	54.4	29/32	0.13	1/2	3500	240

MALE BULKHEAD CONNECTORS

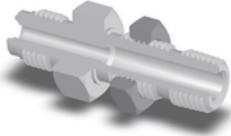
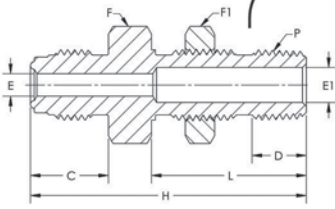

P Male NPT Size	Ordering Number	C		D		E		E1		F Hex Size		F1 Hex Size		H		L		Panel Hole Size	Max Panel Thick- ness	VC Size	Working Pressure	
		in.	mm	in.	mm	in.	mm	in.	mm	in.	mm	in.	mm	in.	mm	psig	bar					
<i>fractional</i>																						
1/4	1-4-VC-A1-4M	0.62	15.7	0.56	14.2	0.18	4.6	0.28	7.1	13/16	13/16	2.21	56.1	1.24	31.5	2 1/32	0.38	1/4	9000	620		
1/4	1-8-VC-A1-4M	0.75	19.1	0.56	14.2	0.40	10.2	0.28	7.1	15/16	13/16	2.34	59.4	1.24	31.5	2 1/32	0.38	1/2	9000	620		

TUBE BUTT WELD BULKHEAD CONNECTORS

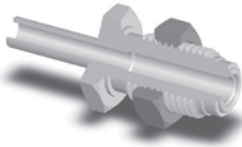
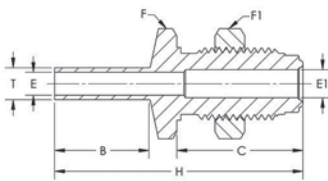

T Tube O.D. Size	Ordering Number	B		C		E		E1		F Hex Size		F1 Hex Size		H		VC Size	Panel Hole Size	Max Panel Thick- ness	Working Pressure	
		in.	mm	in.	mm	in.	mm	in.	mm	in.	mm	in.	mm	psig	bar					
<i>fractional</i>																				
1/4	3-EP-4-VC-61-4TB7	0.75	19.1	1.30	33.0	0.18	4.6	0.22	5.6	3/4	3/4	2.36	59.9	1/4	19/32	0.44	5100	350		
1/4	3-EP-4-VC-A61S-4TB7	0.75	19.1	0.99	25.1	0.18	4.6	0.22	5.6	3/4	3/4	1.95	49.5	1/4	19/32	0.13	5100	350		

COAX TUBE WELD BULKHEAD CONNECTORS

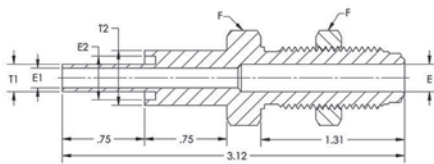
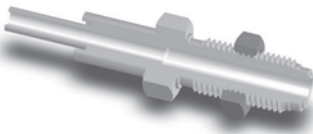

T1 Tube OD Size 1	T2 Tube OD Size 2	Ordering Number	E1		E2		E		F Hex Size	VC Size	Panel Hole Size	Max Panel Thick- ness
			in.	mm	in.	mm	in.	mm				
<i>fractional</i>												
1/4	1/2	3-EP-4-VC-C61-4-8TB7	0.18	4.6	0.40	10.2	0.25	6.4	3/4	1/4	19/32	0.44
3/8	5/8	3-EP-4-VC-C61-6-10TB7	0.31	7.7	0.53	13.5	0.25	6.4	3/4	1/4	19/32	0.13

REDUCING UNIONS

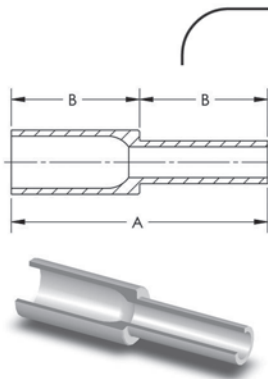

Tube OD	Wall Thickness	Tube OD	Wall Thickness	Ordering Number	Dimensions		Pressure Rating
					A	B	
<i>Dimensions, in. (mm)</i>					<i>psig (bar)</i>		
3/8	0.035	1/4	0.035	3-EP-6TB7-6-4	1.50 (38.1)	0.75 (19.1)	3300 (227)
1/2	0.049	1/4	0.035	3-EP-8TB7-6-4			3700 (254)
1/2		3/8	0.035	3-EP-8TB7-6-6			3300 (227)
<i>Dimensions, mm (in.)</i>					<i>bar (psig)</i>		
10	1	6	1.0	3-EP-10MTB7-6-6M	38.1 (1.50)	19.1 (0.75)	240 (3483)
10		8		3-EP-10MTB7-6-8M			
12		6		3-EP-12MTB7-6-6M			
12		8		3-EP-12MTB7-6-8M			
12		10		3-EP-12MTB7-6-10M			
18	1.5	6	1.0	3-EP-18MTB7-6-6M			200 (2902)
18		12		3-EP-18MTB7-6-12M			

SHORT REDUCING UNIONS

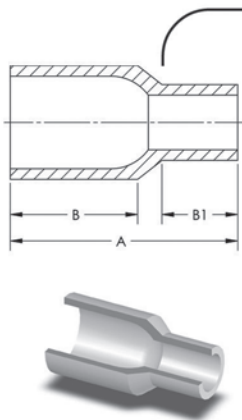

Tube OD	Wall Thickness	Tube OD	Wall Thickness	Ordering Number	Dimensions			Pressure Rating
					A	B	B1	
<i>Dimensions, in. (mm)</i>					<i>psig (bar)</i>			
1/4	0.035	1/8	0.028	3-EP-4MW-6-2	0.75 (19.1)	0.42 (10.7)	0.25 (6.4)	5100 (351)
3/8		1/4		3-EP-6MW-6-4				3300 (227)
1/2	0.049	1/4	0.035	3-EP-8MW-6-4				3700 (254)
1/2		3/8	0.035	3-EP-8MW-6-6				3300 (227)

HIGH FLOW CONNECTIONS

TUBE BUTT WELD

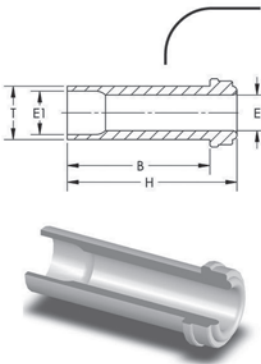

T Tube OD	Ordering Number	B		E		E1		H		VC Size	Nominal Wall Thickness	Working Pressure	
		in.	mm	in.	mm	in.	mm	in.	mm			psig	bar
<i>fractional</i>													
3/8	3-EP-4-HVC-3-.60SR	0.41	10.4	0.25	6.4	0.31	7.9	0.60	15.2	1/4	0.035	3300	220
3/8	3-EP-4-HVC-3-1.19SR	1.00	25.4	0.25	6.4	0.31	7.9	1.19	30.2	1/4	0.035	3300	220
3/8	3-NEP-4-HVC-3-1.19SR	1.00	25.4	0.25	6.4	0.31	7.9	1.19	30.2	1/4	0.035	3300	220
3/8	3-EP-4-HVC-3-1.31SR	1.12	28.4	0.25	6.4	0.31	7.9	1.31	33.3	1/4	0.035	3300	220
3/8	3-NEP-4-HVC-3-1.31SR	1.12	28.4	0.25	6.4	0.31	7.9	1.31	33.3	1/4	0.035	3300	220

HIGH FLOW FEMALE NUT

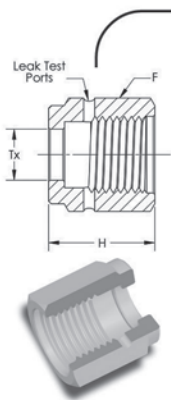

Ordering Number	F Hex Size	H		Tx	
		in.	mm	in.	mm
1-4-HVC-1	3/4	0.81	20.6	0.39	9.9

HIGH FLOW MALE NUT

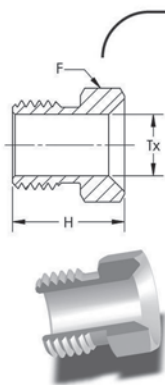

Ordering Number	F Hex Size	H		Tx	
		in.	mm	in.	mm
1-4-HVC-4	5/8	0.71	18	0.39	9.9

TUBE BUTT WELD BODIES

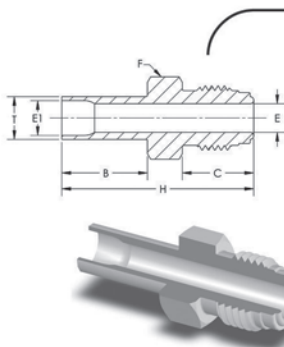

T Tube OD	Ordering Number	B		C		E		E1		F Hex Size	H		Working Pressure	
		in.	mm	in.	mm	in.	mm	in.	mm		psig	bar		
<i>fractional</i>														
3/8	3-EP-4-HVC-1-6TB7	0.75	19.1	0.62	15.7	0.25	6.4	0.31	7.9	5/8	1.68	42.7	3300	220

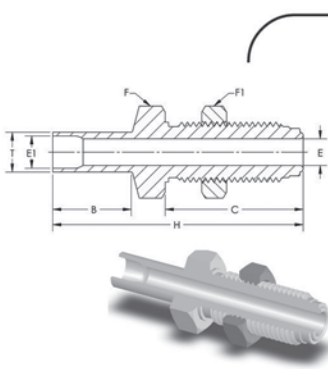

BULKHEAD CONNECTOR

T Tube OD	Ordering Number	B		C		E		E1		F Hex Size	F1 Hex Size	H		Panel Hole Size	Max Panel Thick- ness	Working Pressure	
		in.	mm	in.	mm	in.	mm	in.	mm			in.	mm			psig	bar
<i>fractional</i>																	
3/8	3-EP-4-HVC-61-6TB7	0.75	19.1	1.30	33.0	0.25	6.4	0.31	7.9	3/4	3/4	2.36	59.9	19/32	0.44	3300	220

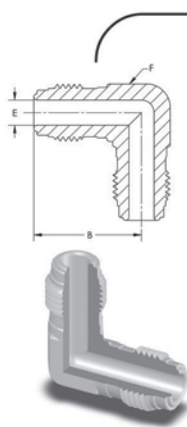

UNION ELBOW

Ordering Number	B		E		F Wrench Size	Working Pressure	
	in.	mm	in.	mm		psig	bar
1-4-HVC-9	1.07	27.2	0.25	6.4	9/16	8000	550

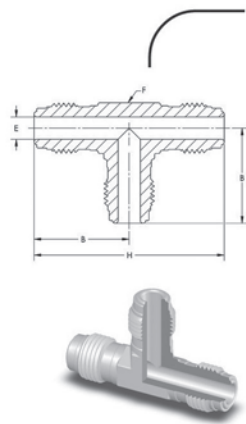

UNION TEE

VCR Size In	Ordering Number	Dimensions				Working Pressure		
		B	E	H	F Size	M	SS	Cu
		<i>Dimensions, in. (mm)</i>				<i>psig (bar)</i>		
1/4	1-4-HVC-T	1.07 (27.2)	0.25 (6.4)	2.14 (54.6)	9/16	10000 (667)	5400 (440)	

GASKETS

FLAT GASKETS WITHOUT RETAINER

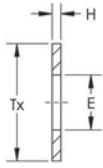

Ordering Number		VC Size	Dimensions, in. (mm)			NOTES
316L Stainless Steel	Nickel		Tx (dia.)	E (dia.)	H	
SS-2-VC-2	NI-2-VC-2	1/8	0.26 (6.6)	0.09 (2.3)	0.028 (0.7)	Cannot be used in a gasket retainer assembly
SS-4-VC-2	NI-4-VC-2	1/4	0.47 (11.9)	0.22 (5.6)		
SS-8-VC-2	NI-8-VC-2	1/2	0.78 (19.8)	0.44 (11.2)		
SS-12-VC-2	NI-12-VC-2	3/4	1.14 (29.0)	0.66 (16.8)		
SS-16-VC-2	NI-16-VC-2	1	1.40 (35.6)	0.89 (22.6)		

FLAT GASKETS WITH RETAINER

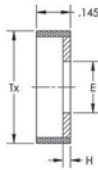

Ordering Number		VC Size	Dimensions, in. (mm)			NOTES
316L Stainless Steel	Nickel		Tx (dia.)	E (dia.)	H	
SS-4-VC-2-R	NI-4-VC-2-R	1/4	0.48 (12.0)	.22 (5.6)	0.028 (0.7)	Retainer & gasket must be used as an assembly
SS-8-VC-2-R	NI-8-VC-2-R	1/2	.78 (19.7)	0.44 (11.2)		

Note: Gasket retainer is made from ETFE resin suitable for service temperatures up to 150°C. This novel design eliminates many of the sealing issues associated with metal retainers due to installation damage to the gland sealing beads.

BLIND GASKETS, NICKEL ONLY

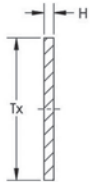

Ordering Number	VC Size	Dimensions, in. (mm)	
		Tx (dia.)	H
NI-4-VC-2-BL	1/4	0.47 (11.9)	0.028 (0.7)
NI-8-VC-2-BL	1/2	0.78 (19.8)	

TEST GASKETS, NON-POLISHED

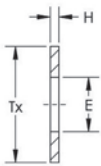

Ordering Number	VC Size	Dimensions, in. (mm)		
		Tx (dia.)	E (dia.)	H
NI-4-VC-2-T	1/4	0.47 (11.9)	0.22 (5.6)	0.028 (0.7)
NI-8-VC-2-T	1/2	0.78 (19.8)	0.44 (11.2)	

MALE NPT CONNECTORS

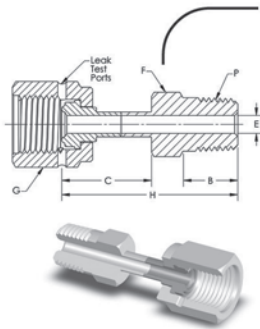

P Male NPT Size	Ordering Number	B		C		E		F Hex Flat	G Hex Flat	H		VC Size	Working Pressure	
		in.	mm	in.	mm	in.	mm	in.	mm	in.	mm		psig	bar
<i>fractional</i>														
1/8	3-EP-4-WVC-1-2	0.38	9.6	0.95	24.1	0.18	4.6	7/16	3/4	1.58	40.1	1/4	8000	550
1/4	3-EP-4-WVC-1-4	0.56	14.2	0.92	23.4	0.18	4.6	9/16	3/4	1.79	45.5	1/4	8000	550
3/8	3-EP-8-WVC-1-6	0.56	14.2	1.00	25.4	0.40	10.2	1 1/16	1 1/16	1.89	48.0	1/2	3500	240
1/2	3-EP-8-WVC-1-8	0.75	19.1	1.01	25.6	0.40	10.2	7/8	1 1/16	2.09	53.1	1/2	3500	240

FEMALE NPT CONNECTORS

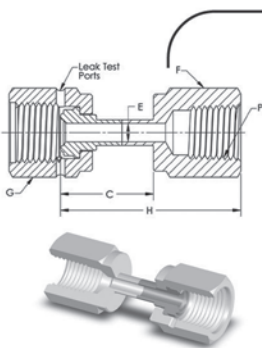

P Female NPT Size	Ordering Number	C		E		F Hex Flat	G Hex Flat	H		VC Size	Working Pressure	
		in.	mm	in.	mm	in.	mm	in.	mm		psig	bar
<i>fractional</i>												
1/4	3-EP-4-WVC-7-4	0.92	23.4	0.18	4.6	3/4	3/4	1.77	45.0	1/4	6600	450
3/8	3-EP-8-WVC-7-6	1.06	26.9	0.40	10.2	7/8	1 1/16	1.95	49.5	1/2	3500	240
1/2	3-EP-8-WVC-7-8	1.04	26.4	0.40	10.2	1 1/16	1 1/16	2.18	55.4	1/2	3500	240

ROTATING FEMALE UNIONS

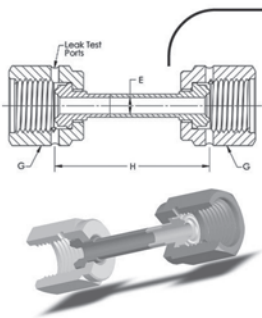

Ordering Number	E		G Hex Flat	H		VC Size	Working Pressure	
	in.	mm	in.	mm	psig		bar	
3-EP-4-WVC-6-DF	0.18	4.6	3/4	1.71	43.4	1/4	8000	550
3-EP-8-WVC-6-DF	0.40	10.2	1 1/16	1.84	46.7	1/2	3500	240

FEMALE ELBOW

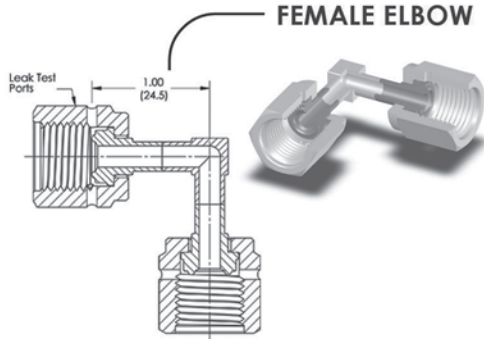

3-EP-4-WVC-9-FF

FEMALE TEE

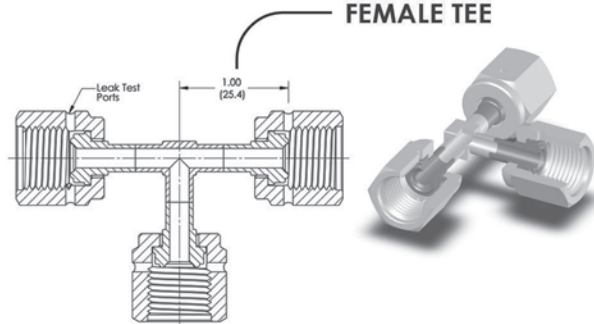

3-EP-4-WVC-T-FFF

UHP PROCESS & MATERIAL SPECIFICATION



BAR MegaClean UHP™ Ultra High Purity Process Specification REV.B

SCOPE:

This document specifies guidelines used by BAR Manufacturing, LLC for producing MegaClean UHP™ ultra high purity electropolished stainless steel products. This document must be used in conjunction with product catalogs, technical bulletins and reports for complete product information.

Note: The BAR MegaClean UHP Process Specification is a living document and is subject to change. For the latest version, please check our website: www.barmfg.us (downloads)

MATERIALS GUIDELINES

Stainless steel bar stock conforms to the following standards:

- ASTM A 479, "Stainless and Heat-Resisting Bars and Shapes for Use in Boilers and Other Pressure Vessels"
- ASTM A 484, "Specification for General Requirements for Stainless and Heat-Resisting Bars, Billets, and Forgings"
- ASTM A 276, "Stainless and Heat-Resisting Bars and Shapes"
- All MegaClean UHP™ gas fittings are fabricated from stainless steel material meeting the requirements for SEMI F20 with the exception that the sulfur content shall be less than or equal to 0.010%. BAR uses vacuum arc remelt (VAR) 316L stainless steel for MegaClean UHP™ gas fittings.

ULTRA HIGH PURITY PROCESS SPECIFICATION (MegaClean UHP™)

Manufacturing and Surface Finish

During manufacturing, dimensions and surface finishes are monitored closely. Each machined component has extremely fine surface finishes, smooth transitions, fully swept flow paths and square weld ends to minimize the number of entrapped or generated particles.

- Dimensions and tolerances meet the requirements of specified in SEMI F44, "Guideline for Standardization of Machined Stainless Steel Weld Fittings".
- The roughness measurement, Ra, is defined by ASME B46.1, "Surface Texture (Surface Roughness, Waviness and Lay)," as the arithmetic average of the absolute values of the profile height deviations recorded within the evaluation length and measured from the mean line.
- Surface roughness/finish is verified by using a suitable profiling instrument in accordance with ASME B46.1. Measurements are taken over the maximum available length of the fitting or valve bore, excluding tapered surfaces, intersections, or welds.
- Surface roughness/finish criteria are based on SEMI F19, "Specification for the Finish of the Wetted Surfaces of Electropolished 316L Stainless Steel Components" and the procedures of SEMI F37, "Method for Determination of Surface Roughness Parameters for Gas Distribution System Components."
- Gas wetted surfaces of ultra high purity stainless steel products are produced with an Ra of less than 5 µin. (0.13 µm) and a maximum Ra of 10 µin. (0.25 µm).
- BAR Manufacturing, LLC does not use mercury or ozone depleting chemicals in the processing of our products.
- Sulfur free cutting and cooling fluids are used during the manufacturing process.

ELECTROPOLISHING AND PASSIVATION

The wetted surfaces of fittings and valve bodies are electropolished to improve surface conditions and to form a corrosion resistant surface layer of chromium oxide. After electropolishing, all surfaces are passivated to remove free iron.

- Passivation processes are based on ASTM A967, "Standard Specification for Chemical Passivation Treatments for Stainless Steel Parts".
- Verification of electropolishing and passivation is performed in accordance with the requirements listed on the following page.

VERIFICATION METHODS AND SPECIFICATIONS

Parameter	Specification	Test Method
Chromium-to-Iron (Cr/Fe)	<ul style="list-style-type: none"> Ratio ≥ 2.0 Ratio ≥ 1.0 at 10Å after subtraction of Carbon layer 	ESCA (Electron Spectroscopy for Chemical Analysis) per SEMATECH 90120403B, also called XPS (X-ray Photoelectron Spectroscopy)
Chromium oxide-to-iron oxide (CrO/FeO)	Ratio ≥ 3.0	
Oxide thickness	$\geq 20\text{\AA}$ after subtraction of Carbon layer	AES (Auger Electron Spectroscopy) per SEMATECH 91060573B
Carbon Layer	$\leq 10\text{\AA}$ (no evidence of detached iron oxide layer)	
Surface Contamination	(In Atomic Percentage) <ul style="list-style-type: none"> Carbon < 30.0 Sulfur < 1.0 Phosphorus < 2.0 Silicon < 1.5 Nitrogen < 2.0 	
Surface Defects	<ul style="list-style-type: none"> ≤ 25 defects over 5 sample areas ≤ 15 defects total average 	SEM (Scanning Electron Microscopy) per SEMATECH 90120401B
Total Anionic Contamination	<ul style="list-style-type: none"> Total anionic contamination added to the test water ≤ 1 ppm Individual anionic contaminant added to the test water ≤ 0.2 ppm 	ASTM D 4327 (Total Anions)
Appearance	All parts will be highly reflective mirror-like with consistent roughness and a uniform lustrous finish.	Finished parts are visually inspected by the unaided eye using additional bright light

PACKAGING AND IDENTIFICATION

Parts are laser engraved with material heat codes for material traceability. All fittings are packaged in our cleanroom to keep them free from outside contaminants during shipping. Identification and traceability information is visible without opening the product package to reduce the chances for contamination of the product and the system to which it is being assembled.

Packaging and identification procedures meet the requirements:

- SEMI E49.6, "Guide for Subsystem Assembly and Testing Procedures-Stainless Steel Systems"

CLEANING AND DRYING

The DI water cleaning system is closed to the outside environment and thereby limits particle contamination. Products move through a series of ultrasonic washing and multistage DI water rinse tanks directly into the cleanroom for drying, final inspection and packaging.

The DI Water characteristics are based on the guidelines of:

- SEMI E49.6, "Guide for Subsystem Assembly and Testing Procedures-Stainless Steel Systems".

DI WATER CHARACTERISTICS

Characteristic	Bar Manufacturing, LLC Capabilities
Resistivity	$\geq 17.5 \text{ M}\Omega \cdot \text{cm}$ at 25°C (77°F)
Total organic carbon (TOC)	≤ 20 ppb
Silica	≤ 5 ppb
Bacteria	≤ 10 colonies per 100 ml
Hot DI water temperature	167°F (75°C) minimum

ASSEMBLY AND TESTING

To protect parts from airborne contamination, parts are protected and transported directly from the established cleaning system to a clean environment for assembly and testing.

- Cleanroom areas are particle tested and classified in accordance with ISO 14644-1, "Cleanrooms and Associated Controlled Environments." The particle count values listed represent maximum concentration limits (particles per cubic meter of air) of particles $\geq 0.5 \mu\text{m}$.

CLEANROOM AND WORK AREA CLASSIFICATIONS

Location of Testing	Federal Standard 209E	ISO 14644-1 (Articles per Cubic Meter)
Cleanroom	Class 100	Class 5 (3520)

REFERENCED DOCUMENTS

ASME

- ASME B46.1, "Surface Texture (Surface Roughness, Waviness and Lay)"

ASTM

- ASTM A262, "Standard Practices for Detecting Susceptibility to Intergranular Attack in Austenitic Stainless Steels"
- ASTM A276, "Stainless and Heat-Resisting Bars and Shapes"
- ASTM A380, "Cleaning, Descaling, and Passivation of Stainless Steel Parts, Equipment, and Systems"
- ASTM A479, "Stainless and Heat-Resisting Bars and Shapes for Use in Boilers and Other Pressure Vessels"
- ASTM A484, "Specification for General Requirements for Stainless and Heat-Resisting Bars, Billets, and Forgings"
- ASTM A751, "Test Methods, Practices, and Terminology for Chemical Analysis of Steel Products"
- ASTM E45, "Standard Practice for Determining the Inclusion Content of Steel, Method A"
- ASTM E1558, "Electrolytic Polishing of Metallographic Specimens"
- ASTM F1374, "Standard Test Method for the Determination of Ionic/Organic Extractables of Internal Surfaces-IC/GC/FTIR for Gas Distribution System Components"
- ASTM F1398, "Standard Test Method for Determination of Total Hydrocarbon Contribution by Gas Distribution System Components"

ISO

- ISO 14644-1, "Cleanrooms and Associated Controlled Environments"

SEMI

- SEMI E49.6, "Guide for Subsystem Assembly and Testing Procedures-Stainless Steel Systems"
- SEMI E49.7, "Purity Guide for the Design and Manufacture of Ultrapure Water and Liquid Chemical Systems in Semiconductor Process Equipment"
- SEMI E49.9, "Guide for Ultrahigh Purity Gas Distribution Systems in Semiconductor Manufacturing Equipment" (pending adoption of SEMI E49.8 revision)
- SEMI F19, "Specification for the Surface Condition of the Wetted Surfaces of Stainless Steel Components"
- SEMI F37, "Method for Determination of Surface Roughness Parameters for Gas Distribution System Components"
- SEMI F44, "Guideline for Standardization of Machined Stainless Steel Weld Fittings"
- SEMI F60, "Test Method for ESCA Evaluation of Surface Composition of Wetted Surfaces of Passivated 316L Stainless Steel Components"
- SEMI F72, "Test Method for Auger Electron Spectroscopy (AES) Evaluation of Oxide Layer of Wetted Surfaces of Passivated 316L Stainless Steel Components"
- SEMI F73, "Test Method for Scanning Electron Microscopy (SEM) Evaluation of Wetted Surface Condition of Stainless Steel Components"

SEMATECH

- 90120401B, "SEMASPEC Test Method for SEM Analysis of Metallic Surface Condition for Gas Distribution Components"
- 90120403B, "SEMASPEC Test Method for XPS analysis of Surface Composition and Chemistry of Electropolished Stainless Steel Tubing for Gas Distribution System Components"
- 91060573B "SEMASPEC Test Method for Auger Electron Spectroscopy (AES) Analysis of Surface and Oxide Composition of Electropolished Stainless Steel Tubing for Gas Distribution System Components"

COMPANY INFORMATION



TRUST THE MOST EXPERIENCED TEAM IN THE INDUSTRY.
SPECIALIZING IN UHP FITTINGS, VALVES, REGULATORS, VACUUM GENERATORS, KIS BLOCKS AND CUSTOM UHP MACHINING!

BAR Manufacturing, LLC is the leader of quality manufactured parts. It is our intention to ensure customer satisfaction through on time delivery, high quality, and low cost without any compromise to the integrity of our products.

By combining the best materials for the job and implementing innovative techniques to our machining processes, we are able to bring the highest quality products to our customers in record time. With our numerous facilities located in California, China & Thailand we can offer our customers global hands-on support.

Our facilities include over 400,000 square feet of manufacturing and clean room space also containing over 400 CNC Machining Centers and many other types of high precision machinery. We are fully equipped to handle stamping, molding, coiling, polishing, milling and automated clamping.

We also have a wide array of inspection equipment, including a Contamination Control Laboratory that ensures our high quality products.



Our Mission Statement.

BAR Manufacturing is a growth-oriented company providing high value components to several industries. We create value for our employees, customers, shareholders and suppliers.

Our Quality Policy.

BAR Manufacturing, LLC is committed to our customers and meeting their requirements. We will strive to perform error free work and realize continual improvement of our Quality System. Our company training program ensures that the management commitment to quality is understood, implemented and maintained at all levels of the organization.

We are Certified!

BAR Manufacturing is **ISO Certified and The Compant Group is ISO and QS Certified.** Our experienced staff and management conducts comprehensive and rigorous quality inspections concurrent with all industry regulations.

BAR Manufacturing is an active member of the **Compressed Gas Association.** Our membership is essential to the development and promotion of the industrial gas and CGA industries.

Value Added

From start to finish our services are unmatched. We strive to provide the most efficient and best-in-class services to our customers. With over 300 engineers and the most experienced management team within the industry, we can meet and ensure our customers demands. Our global work force consists of 9,000 well trained employees with extensive backgrounds in machining and ultra high purity processes.

International R&D and Manufacturing Capabilities - With our in-house team located in North America and China, we can provide extensive R&D services to our customers without hesitation. With global manufacturing, our capabilities service our customers challenges and requests.

Software and Product Files - We can receive a wide variety of CAD files, but do prefer drawings and solid models in native formats or an "IGES" file to facilitate CNC programming. At BAR and our partner company Compant, we work with the following CAD software systems: Pro/Engineer, SolidWorks, AutoCAD and Inventor.

Industries We Serve:

- Ultra High Purity
- Semi-Conductor
- Micro Electronics
- Process Automation
- Automotive
- Telecommunications
- Medical/Bio-Tech
- Control Valve
- PCB Test Components
- Nuclear
- Aviation/Aerospace
- Food/Agricultural

Areas We Specialize In:

- Precision Machining (Milling & Turning)
- Precision Stamping
- Metal Finishing
- Hand Polishing
- Coil Winding
- Overmolding
- Secondary Clean Room Assembly
- Contamination Control Lab Testing



BAR Manufacturing, LLC - A SUBSIDIARY OF THE COMPART GROUP



In 2004, BAR Manufacturing became a subsidiary of The Compant Group. The Compant Group specializes in precision machining technology. With BAR's many years of expertise and Compant's facilities we are always on the leading edge of the fittings and components industry.

As partners, we both believe that customer satisfaction is our No. 1 priority. Our goal is to help our customers become more FINANCIALLY SUCCESSFUL! This is achieved by carefully listening to our customer's needs, developing a cohesive plan, implementation of that plan, monitoring the key metrics and putting in place a continuous improvement program throughout the project process.

ISO 9001



A Member of the Compressed Gas Association



BAR Manufacturing, LLC 3921 Sandstone Drive, El Dorado Hills, CA 95762
Tel: 916-939-0551 **Fax:** 916-939-7742 **Web:** www.barmfg.us